

Product Introduction of Moso

SPS BU 2022 Version

MOSO | SPS Business Unit | JAMA | 2022-11-11





Product type & sales share of Moso Group

MOSO Power
50%
(SPS BU)



MOSO Electronics
45%
(LED BU)



MOSO New Energy
5%
(Photovoltaic power station operation)





SPS Business Unit Product Roadmap.

- S** Small Power
- M** Medium Power
- L** Large Power

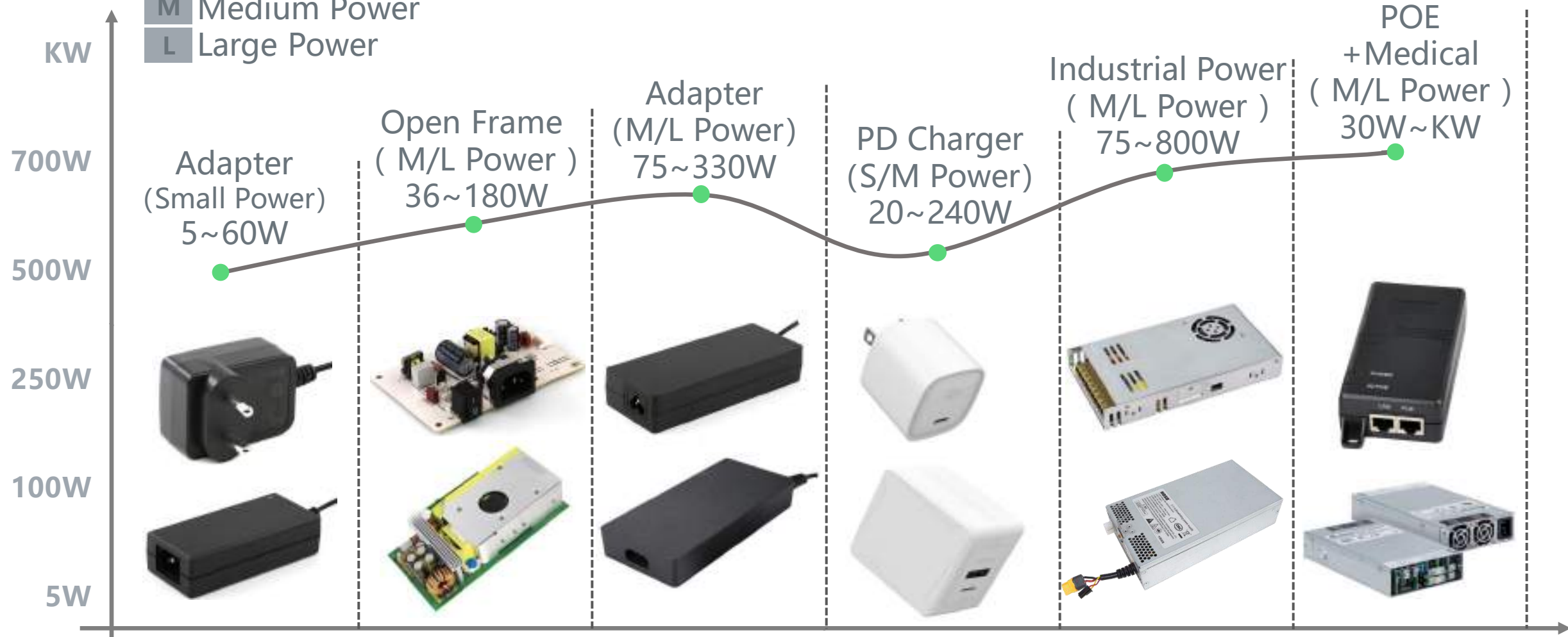



SPS Business Unit Product Application.

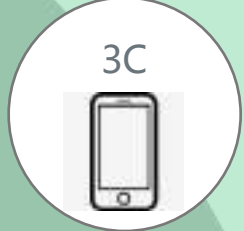
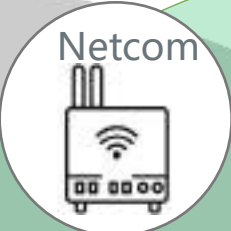

Adapters

PD Chargers

Industrial PSU



SPS BU
(Switch-mode Power Supply)
Product Lines 3

Application:
(13 Category)

Adapter 5~330W

PD Charger 20~240W

Open Frame 36~180W

Industrial Power 75~800W

MOSO SPS BU Main Client

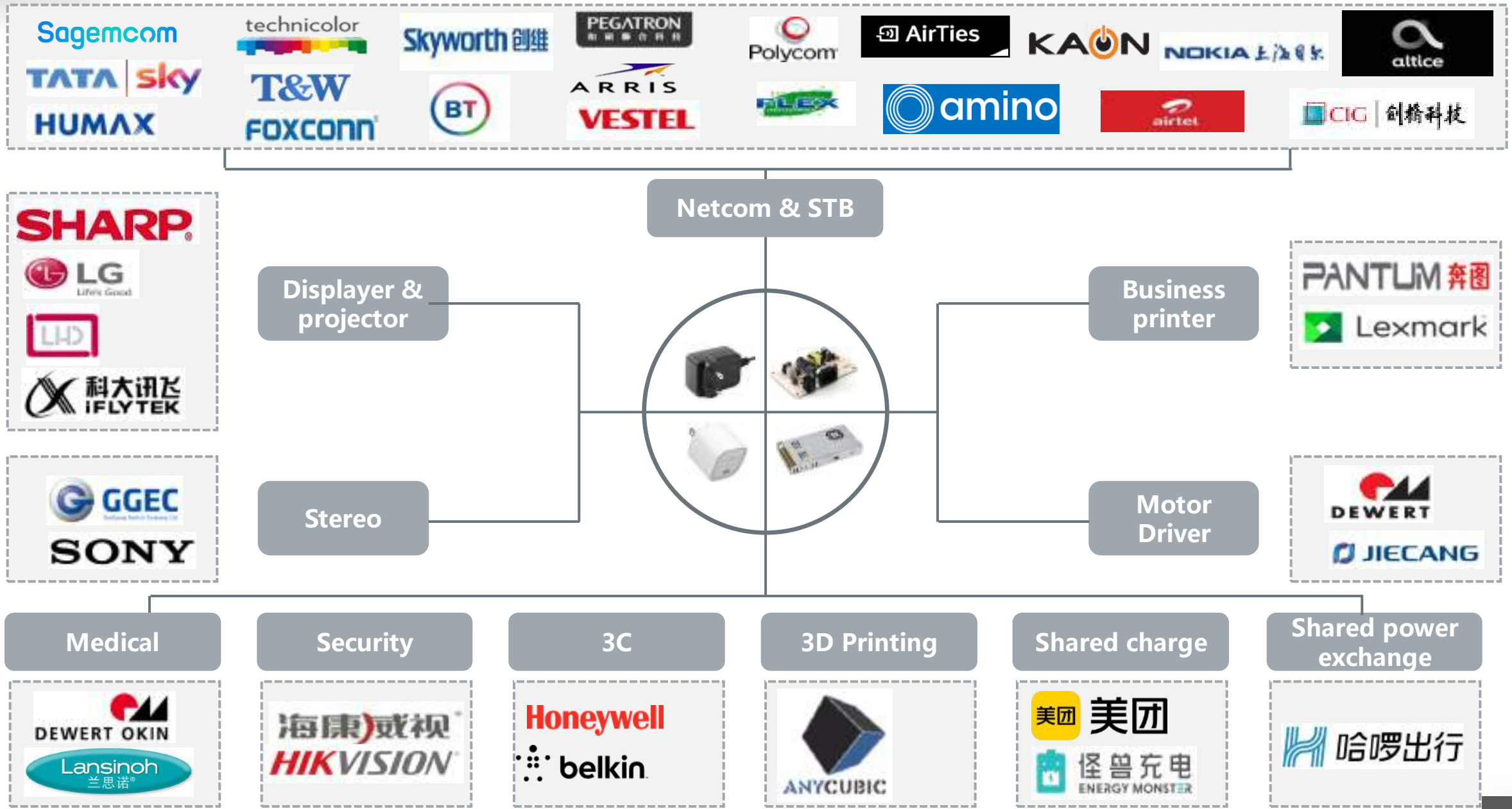

MOSO SPS BU Product Line



Adapter

(Plastic housing, PCBA assembly)

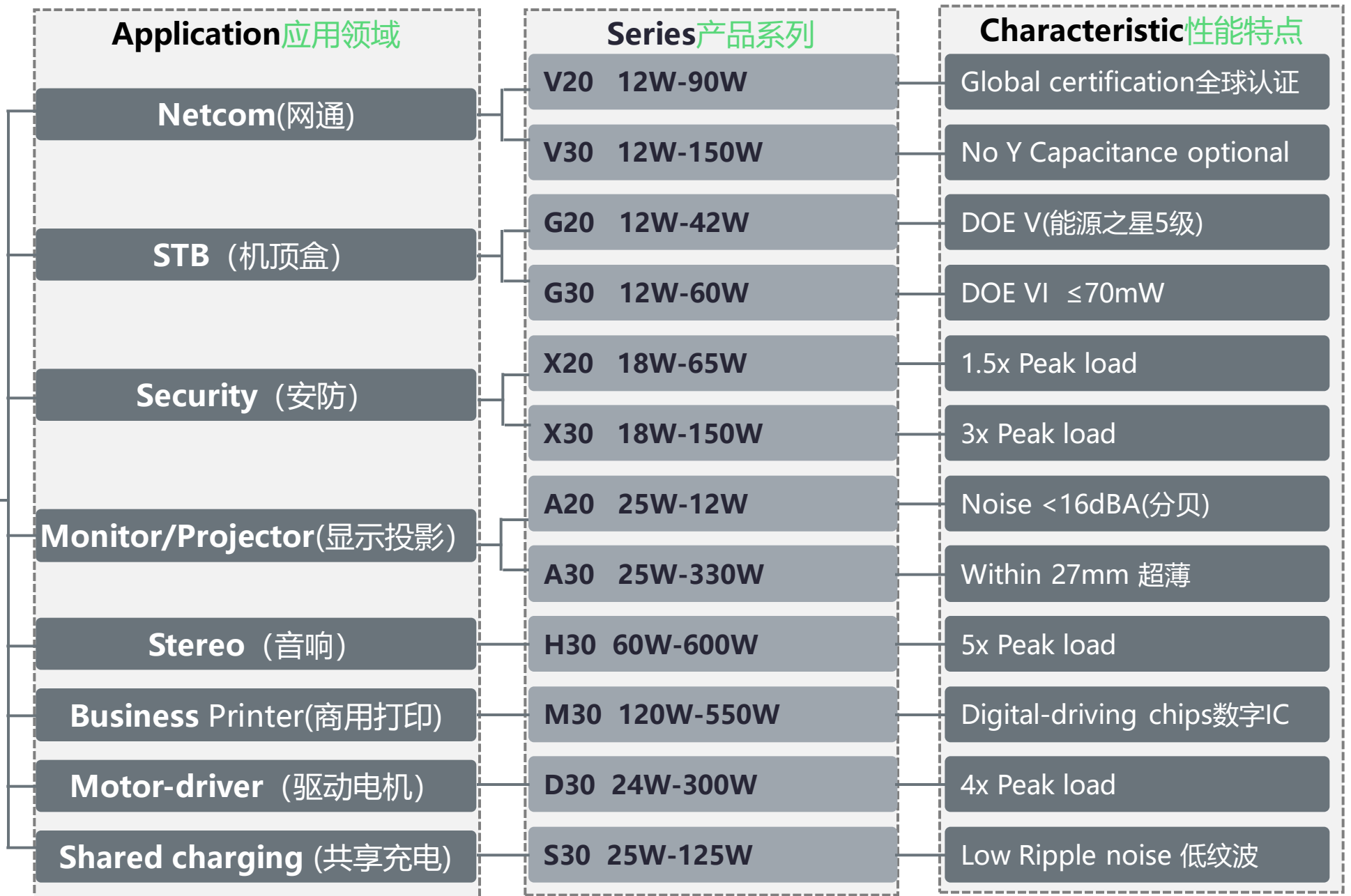

MOSO SPS BU Product Line



Charger

3C Products

P20 20W-65W

CoC V5 tier 2(欧洲6级能效)

P30 20W-240W

Smart Multi-ports(多路输出), GaN Solution



Industry Power
(Case of metal)

**3D printer
(打印)**

E30 150W-500W

Efficiency up to 90%

**Industry equipment
(工业设备)**

T30 100W-3000W

DSP control

**Shared power
exchange (换电站)**

F30 500W-750W

CAN communicate

Application: ①STB (G) + ②Netcom (V)

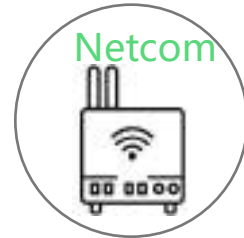

STB机顶盒



WiFi 无线路由器 (AP)
WiFi Router



路由器Router



光纤网络存取设备
Network storage device



无线网关
WiFi Gateway



IP会议电话
IP conference call

STB机顶盒-Adapter适配器 (Small Power)

Power coverage : 12W~60W
Voltage coverage : 5V, 9V, 12V



Netcom网通- Adapter适配器 Open Frame 1% (S/M Power)

Power coverage : 12W~150W
Voltage coverage : 5V, 9V, 12V,
18V, 22V, 24V, 36V, 48V, 50V

MOSO Application: ③ Security (X)



Camera
前端产品



Thermal Imaging Product
热成像产品



smart transportation
智能交通



Intercom
对讲产品



Access Control Equipment
门禁设备

Adapter适配器/ Case Frame 5%
(S/M Power)
Power coverage : 12W~90W
Voltage coverage : 12V, 33V, 36V, 48V

The image shows three different MOSO power adapters. The top one is a black AC adapter with a two-prong plug. The middle one is a silver DC adapter with a label that includes 'MOSO Switching power Adapter', 'IP67', 'LPS', and 'Made in China'. The bottom one is a black DC adapter with a circular output port.



New:210W

**Adapter适配器/
Open Frame 15%**
(M/L Power)
Power coverage :
20W~210W(330W)
Voltage coverage :
19V (18V, 19.5V, 22V)



New:110W

Adapter适配器
(L Power)
Power coverage :
110W/120W/180W/
260W/320W
Voltage coverage :
19V (18V, 19.5V)



New:110W

Open Frame 80%/
Adapter适配器 20%
(M/L Power)

Power coverage : 60W~180W

Voltage coverage : 24V,25V



MOSO Application: ⑥ PD Chargers (P)

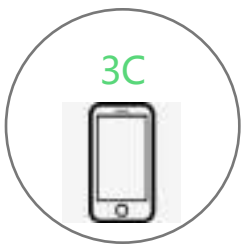

Chargers充电器 (S/M Power)
Power coverage : 20W~140W (200, 240W)
Voltage coverage : 5V/9V/12V~28V,
USB or Type-C



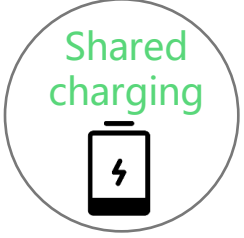

Charger充电器 (S/M Power)
Open Frame 100%
Power coverage : 15W~75W
Voltage coverage : 5V

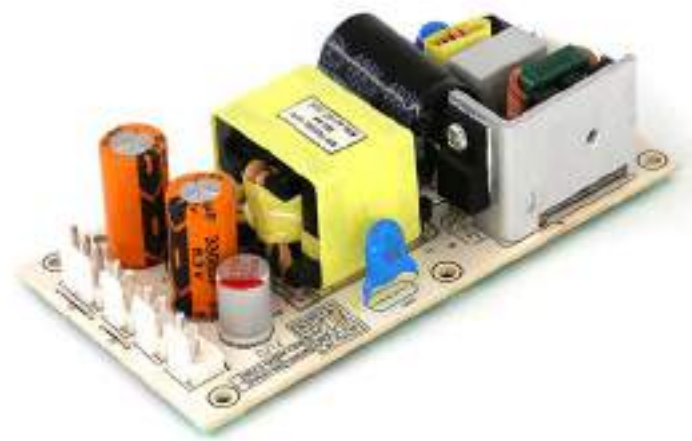

MOSO Application: ⑧ Stereo (H)



**Adapter适配器/
Open Frame 50% (S/M Power)**

Power coverage : 36W~150W
Voltage coverage : 23V, 24V, 25V, 36V, 37V



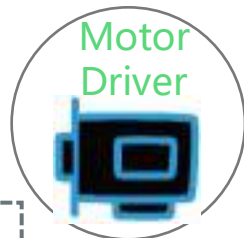

Bedding 升降床
Seating 升降椅
Office 升降桌子
Medical 医学升降

Adapter适配器/ Open Frame 50%
(S/M Power)

Power coverage : 12W~116W

Voltage coverage : 20V, 24V, 27V, 29V, 36V



MOSO Application: ⑩ 3D Printer (E)

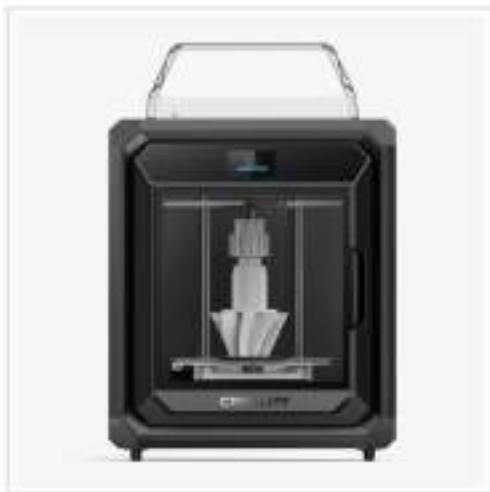
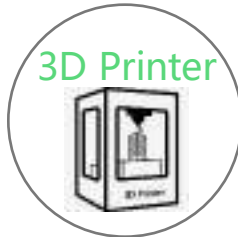

Sermoon D3专业级3D打印机



HALOT-RAY 3D打印机



Sermoon V2 钣金一体式3D打印机



光固化3D打印机HALOT-ONE PLUS



光固化3D打印机HALOT-ONE PRO



Ender-3 S1 Pro 高温淬炼 创意百变

Case Frame (L Power)

Power coverage : 350W

Voltage coverage : 24V, 48V



Motorcycle changing station

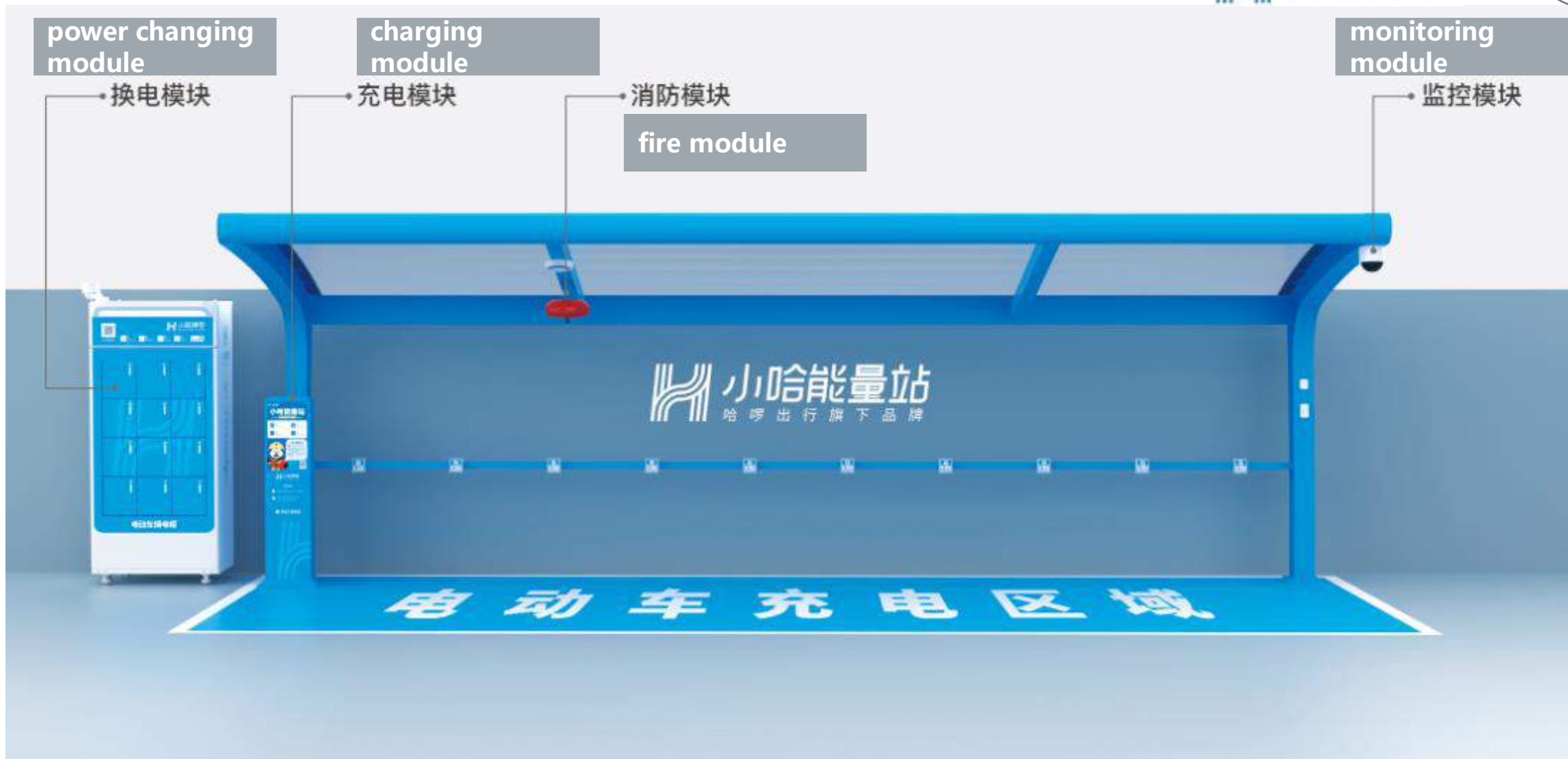
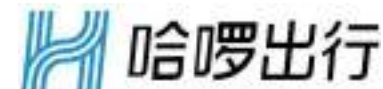

MOSO (11) Shared power exchange (F)

Shared power exchange
换电



小哈智能换电柜
以换代充 极速满电

1台换电柜12个格口
就可以满足近100户居民快速换电需求



The Function of Port Control:

- Control output (on/off)
- Switch mode of Constant Voltage and Current
- Remote OTA Upgrade
- Change the output current/voltage

500W 54V

MOSO (12)Application: Medical

MSP-C2000IC29.0-58W

MSA-C2000IC29.0-58W-GB

58W Wallmount 29V,2A

Medical certification EN60601

Application : Massage chair

SEATING



ilcon
LINEAR ACTUATOR CONCEPTS



DEWERT OKIN

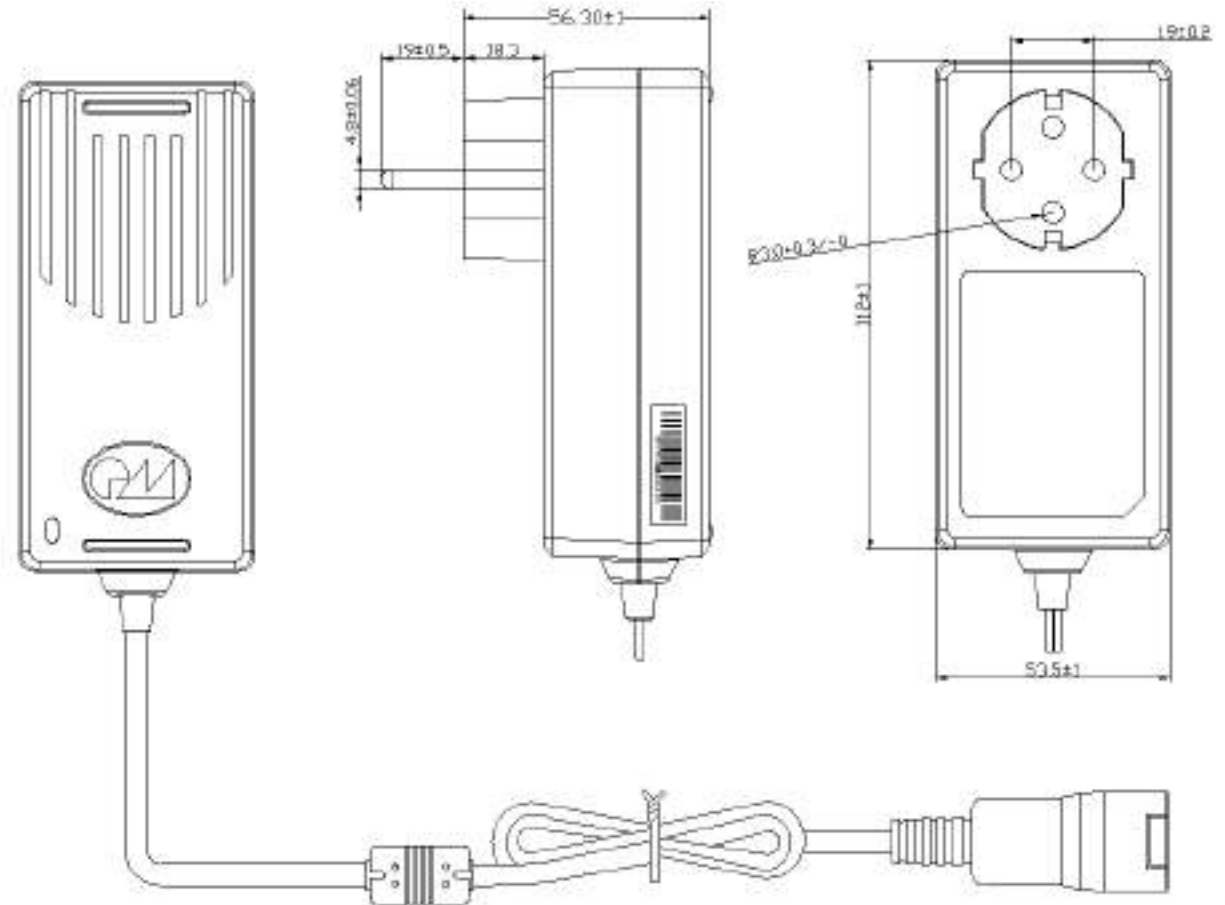

MOSO (12)Application: Medical



MS-H1700R090-010F0-ZZ
15.3W Wall-mount 9V1.7A
Interchangeable Plug
Medical certification EN60601
Application : Breast pump
兰思诺Lansinoh于1984年在美国成立,
30多年来始终母乳喂养的企业

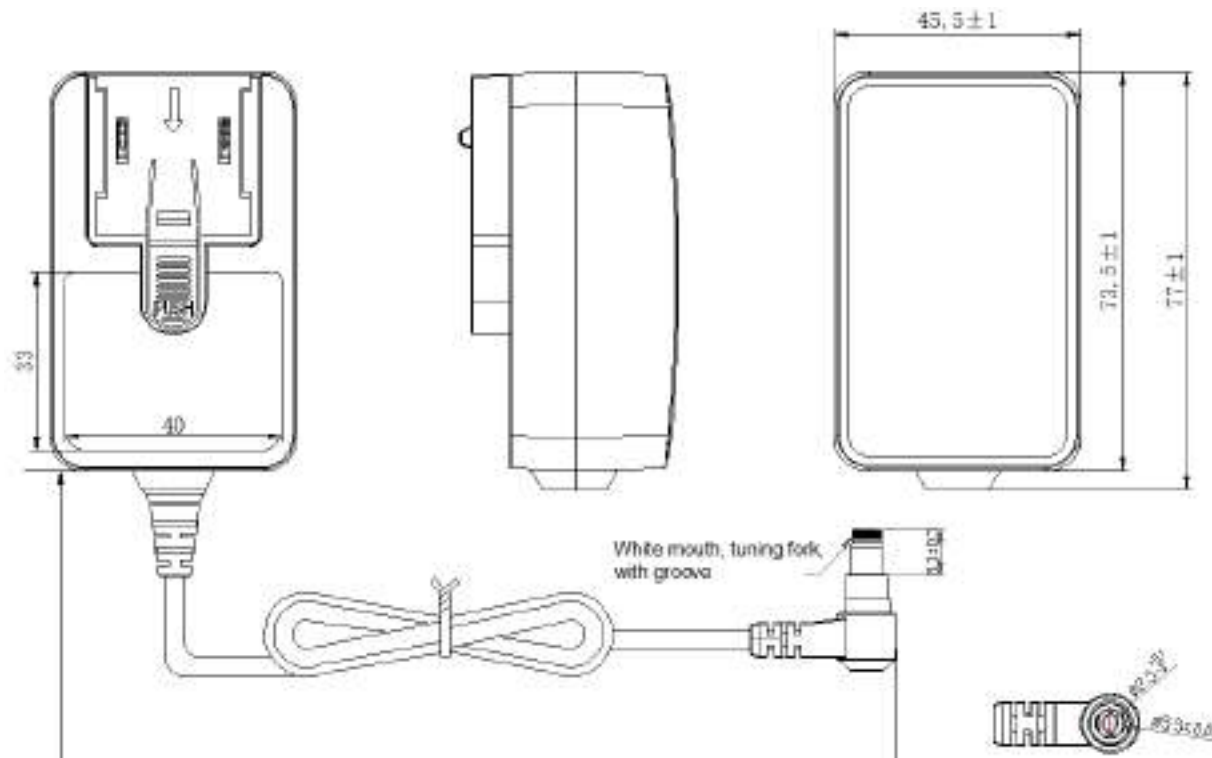



SPS Product family names in different application (14)

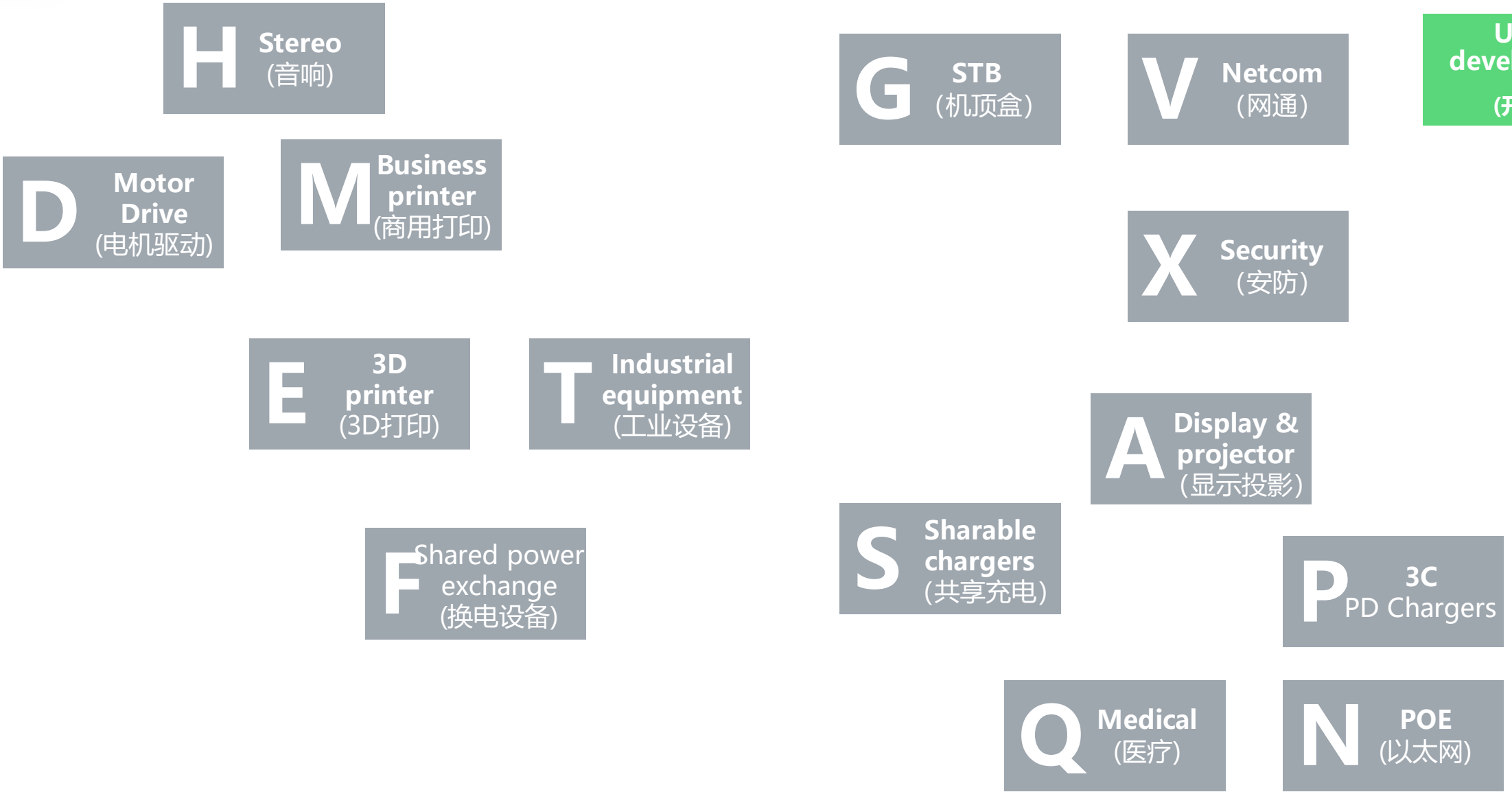

Under development
(开发中)

Adapter, Wall-mount

Input Voltage: 90~264Vac / 47~63Hz

Input Current: <0.3A

Start Inrush Current: 50Amax.

Surge: CM/DM: 6KV max

Protection: OCP, SCP, OVP

Y Cap: With Y-cap

LED Display: No

Product Type: Vertical

AC Plug: CN, US, DE, GB, AU, AG

Dimension: 56.3*28*42.7mm

Working Temperature: 0~45°C

Safety: CE, CB

Application: Set Top Box, ADSL Gateway,
Mobile Storage Device

6W
G30/ V30
Series:

G STB
(机顶盒)

V Netcom
(网通)



| Model | T (V) | Voltage (V) | Current (A) | Ripple (mV) | Power Max(w) | Efficiency (V/ VI) |
|--------------------|-----------|----------------|----------------|----------------|-----------------|-----------------------|
| MS-V0500R120-006D0 | T1: 9-12V | 12 | 0.5 | 120 | 6.0 | VI |

Adapter, Wall-mount

Input Voltage: 90~264Vac / 47~63Hz

Input Current: <0.5A

Start Inrush Current: 50Amax.

Surge: CM/DM: 4KV max

Protection: OCP, SCP, OVP

Y Cap: With Y-cap

LED Display: No

Product Type: Horizontal

AC Plug: CN, US, DE, GB

Dimension: 58*41.8*34mm

Working Temperature: 0~45°C

Safety: CCC, CE, CB, UL, FCC, UKCA, BIS(5V)

Application: Set Top Box, ADSL Gateway,
Mobile Storage Device

7.5W

G20/ V20

Series:

G STB
(机顶盒)

V Netcom
(网通)



| Model | T (V) | Voltage (V) | Current (A) | Ripple (mV) | Power Max(w) | Efficiency (V/VI) |
|----------------------|-----------|-------------|-------------|-------------|--------------|-------------------|
| MSA-C1500IC5.0-7.5A | T1: 4-6V | 5 | 1.5 | 120 | 7.5 | VI |
| MSA-C0625IC12.0-7.5A | T2: 9-12V | 12 | 0.625 | 120 | 7.5 | VI |

Adapter, Wall-mount

Input Voltage: 90~264Vac / 47~63Hz

Input Current: <0.5A

Start Inrush Current: 40Amax.

Surge: CM: 2KV max; DM: 1KV max

Protection: OCP, SCP, OVP

Y Cap(V30): With single Y-cap

Y Cap(G30): With double Y-cap

Product Type: Vertical

AC Plug: US, DE, GB

Dimension: 48*40.4*24mm

Working Temperature: 0~45°C

Safety(V30): CE, CB, UL, FCC, UKCA, Serbia

Safety(G30): CE, CB, UL, FCC, UKCA

Application: Set Top Box, ADSL Gateway,
Mobile Storage Device

10W
G30/ V30
Series:

G STB
(机顶盒)

V Netcom
(网通)



| Model | T (V) | Voltage (V) | Current (A) | Ripple (mV) | Power Max(w) | Efficiency (V/VI) |
|-----------------------------|----------|-------------|-------------|-------------|--------------|-------------------|
| MS-V2000U050-010D0 (V30) | T1: 3-5V | 5 | 2.0 | 200 | 10 | VI |
| MS-V2000U050-010B0 (G30) | T1: 3-5V | 5 | 2.0 | 200 | 10 | VI |

Adapter, Wall-mount

Input Voltage: 90~264Vac / 47~63Hz

Input Current: <0.3A

Start Inrush Current: 60Amax.

Surge: CM/DM: 6KV max

Protection: OCP, SCP, OVP

Y Cap: With Y-cap

LED Display: Yes

Product Type: Vertical

AC Plug: CN, US, DE, GB, AU, AG

Dimension: 56.3*28*42.7mm

Working Temperature: 0~45°C

Safety: CCC, CE, CB, UL, FCC, SAA,
UKCA, BSMI(5V), SAA(5V), PSE, IRAM

Application: Set Top Box, ADSL Gateway,
Mobile Storage Device

12W
G30/ V30
Series:

G STB
(机顶盒)

V Netcom
(网通)



| Model | T (V) | Voltage (V) | Current (A) | Ripple (mV) | Power Max(w) | Efficiency (V/VI) |
|--------------------|-----------|-------------|-------------|-------------|--------------|-------------------|
| MS-V2000R050-012H0 | T1: 4-6V | 5 | 2.0 | 120 | 10 | VI |
| MS-V1000R120-012H0 | T2: 9-15V | 12 | 1.0 | 120 | 12 | VI |

Adapter, Wall-mount

Input Voltage: 90~264Vac / 47~63Hz

Input Current: <0.3A

Start Inrush Current: 60Amax.

Surge: CM/DM: 4KV max

Protection: OCP, SCP, OVP

Y Cap: With Y-cap

LED Display: Yes

Product Type: Vertical

AC Plug: CN, US, DE, GB, AU

Dimension: 56.3*28*42.7mm

Working Temperature: 0~45°C

Safety: CCC, CE, CB, UL, FCC, GS,
UKCA, UAE

Application: Set Top Box, ADSL Gateway,
Mobile Storage Device

12W
G20T/ V20T
Series:

G STB
(机顶盒)

V Netcom
(网通)

Ready to be taken off the shelves
(即将下架)



| Model | T (V) | Voltage (V) | Current (A) | Ripple (mV) | Power Max(w) | Efficiency (V/ VI) |
|---------------------|-----------|----------------|----------------|----------------|-----------------|-----------------------|
| MSA-C1000IC12.0-12H | T1: 8-12V | 12 | 1.0 | 120 | 12 | VI |

Adapter, Wall-mount

Input Voltage: 90~264Vac / 47~63Hz

Input Current: <0.5A

Start Inrush Current: 60Amax.

Surge: CM/DM 6KV max; K.21

Protection: OCP, SCP, OVP

Y Cap: With Y-cap

LED Display: Yes

Product Type: Vertical

AC Plug: US, DE, GB, AG

Dimension: 68*28*42mm

Working Temperature: 0~45°C

Safety: CE, CB, UL, FCC, UKCA, GS,
S-mark(12V), PSB(12V)

Application: Set Top Box, ADSL Gateway,
Security Monitoring, Mobile Storage Device

12W
G20/ V20/ X20
Series:

G STB
(机顶盒)

V Netcom
(网通)

X Security
(安防)

Ready to be taken off the shelves
(即将下架)



| Model | T (V) | Voltage (V) | Current (A) | Ripple (mV) | Power Max(w) | Efficiency (V/VI) |
|---------------------|-----------|----------------|----------------|----------------|-----------------|----------------------|
| MSA-C2000CS5.0-12A | T1: 4-6V | 5 | 2.0 | 120 | 10 | VI |
| MSA-C1000CS12.0-12A | T2: 9-12V | 12 | 1.0 | 120 | 12 | VI |

Adapter, Wall-mount

Input Voltage: 90~264Vac / 47~63Hz

Input Current: <0.5A

Start Inrush Current: 60Amax.

Surge: CM/DM: 6KV max

Protection: OCP, SCP, OVP

Y Cap: No Y-cap

LED Display: Yes

Product Type: Horizontal

AC Plug: CN, US, DE, IN, JP

Dimension: 73.5*43*36mm

Working Temperature: 0~45°C

Safety: CCC, CE, CB, UL, FCC, BIS, NOM, PSE

Application: ADSL Gateway, Security Monitoring, Mobile Storage Device

12W
V20T/ X20T
Series:

V Netcom
(网通)

X Security
(安防)



| Model | T (V) | Voltage (V) | Current (A) | Ripple (mV) | Power Max(w) | Efficiency (V/ VI) |
|----------------------|-----------|-------------|-------------|-------------|--------------|--------------------|
| MSS-H1000WR120-012B0 | T1: 8-12V | 12 | 1.0 | 120 | 12 | VI |

Adapter, Wall-mount

Input Voltage: 90~300Vac / 47~63Hz

Input Current: <0.5A

Start Inrush Current: 60Amax.

Surge: CM/DM: 4KV max

With input OVP function

Protection: OCP, SCP, OVP

Y Cap: With Y-cap

LED Display: Yes

Product Type: Horizontal

AC Plug: IN

Dimension: 73.5*43*36mm

Working Temperature: 0~45°C

Safety: BIS

Application: Set Top Box, ADSL Gateway,
Mobile Storage Device

12W
G20/ V20
Series:

G STB
(机顶盒)

V Netcom
(网通)



| Model | T (V) | Voltage (V) | Current (A) | Ripple (mV) | Power Max(w) | Efficiency (V/ VI) |
|---------------------|----------|----------------|----------------|----------------|-----------------|-----------------------|
| MSA-C1000CP12.0-12J | T1: 12V | 12 | 1.0 | 150 | 12 | VI |

Adapter, Wall-mount

Input Voltage: 90~264Vac / 47~63Hz

Input Current: <0.5A

Start Inrush Current: 100Amax.

Surge: CM: 2KV max; DM: 1KV max

Protection: OCP, SCP, OVP

Y Cap: With Y-cap

LED Display: Yes

Product Type: Horizontal

AC Plug: DE

Dimension: 71*43*30mm

Working Temperature: -10~45°C

Safety: CE, CB

Application: ADSL Gateway, Netcom

15W
V30
Series:

V Netcom
(网通)



| Model | T (V) | Voltage (V) | Current (A) | Ripple (mV) | Power Max(w) | Efficiency (V/ VI) |
|--------------------|----------|----------------|----------------|----------------|-----------------|-----------------------|
| MS-H3000R050-015P0 | - | 5 | 3 | 120 | 15 | VI |

Adapter, Wall-mount

Input Voltage: 90~264Vac / 47~63Hz

Input Current: <0.6A

Start Inrush Current: 80Amax.

Surge: CM/DM: 4KV max

Protection: OCP, SCP, OVP

Y Cap: With Y-cap

LED Display: No

Product Type: Vertical

AC Plug: US, DE, GB, AU,AG

Dimension: 68*28*42mm

Working Temperature: 0~45°C

Safety: CCC, CE, CB, UL, FCC, UKCA, RCM, SAA, EAC

Application: Set Top Box, ADSL Gateway

Mobile Storage Device

Ready to be taken off the shelves
(即将下架)

18W
G20T/ V20T
Series:

G STB
(机顶盒)

V Netcom
(网通)



| Model | T (V) | Voltage (V) | Current (A) | Ripple (mV) | Power Max(w) | Efficiency (V/ VI) |
|---------------------|-----------|-------------|-------------|-------------|--------------|--------------------|
| MSA-C1500CS12.0-18G | T1: 8-12V | 12 | 1.5 | 120 | 18 | VI |

Adapter, Wall-mount

Input Voltage: 90~264Vac / 47~63Hz

Input Current: <0.6A

Start Inrush Current: 60Amax.

Surge: CM/DM: 6KV max

Protection: OCP, SCP, OVP

Y Cap: With Y-cap

LED Display: Yes

Product Type: Vertical

AC Plug: US, DE, GB, AU, KR

Dimension: 68*28*42mm

Working Temperature: 0~45°C

Safety: CE, CB, UL, FCC, UKCA,
SAA, NOM(12V), KC, UAE(12V)

Application: Set Top Box, ADSL Gateway,
Mobile Storage Device

18W
G30/ V30
Series:

G STB
(机顶盒)

V Netcom
(网通)



| Model | T (V) | Voltage (V) | Current (A) | Ripple (mV) | Power Max(w) | Efficiency (V/VI) |
|--------------------|-----------|-------------|-------------|-------------|--------------|-------------------|
| MS-V2000R090-018H0 | T1: 9-15V | 9 | 2.0 | 120 | 18 | VI |
| MS-V1500R120-018H0 | | 12 | 1.5 | 120 | 18 | VI |

Adapter, Wall-mount

Input Voltage: 90~264Vac / 47~63Hz

Input Current: <0.7A

Start Inrush Current: 70Amax.

Surge: CM/DM: 6KV max

Protection: OCP, SCP, OVP

Y Cap: No Y-cap

LED Display: Yes

Product Type: Vertical

AC Plug: CN, US, DE, GB, AU, AG

Dimension: 56.3*28*42.7mm

Working Temperature: 0~45°C

Safety: NOM

Application: ADSL Gateway, Security Monitoring, Mobile Storage Device



18W
V30/ X30
Series:

V Netcom
 (网通)

X Security
 (安防)



| Model | T (V) | Voltage (V) | Current (A) | Ripple (mV) | Power Max(w) | Efficiency (V/ VI) |
|--------------------|-----------|-------------|-------------|-------------|--------------|--------------------|
| MS-V1500R120-018L0 | T1: 9-15V | 12 | 1.5 | 120 | 18 | VI |

Adapter, Wall-mount

Input Voltage: 90~264Vac / 47~63Hz

Input Current: <1.0A

Start Inrush Current: 80Amax.

Surge: CM/DM: 6KV max, K.21

Protection: OCP, SCP, OVP

Y Cap: With Y-cap

LED Display: Yes

Product Type: Vertical

AC Plug: US, DE, GB, AU, AG

Dimension: 74*32*42mm

Working Temperature: 0~45°C

Safety: CE, CB, UL, FCC, UKCA,

SAA, NOM, IRAM

Application: Set Top Box, ADSL Gateway
Security Monitoring, Mobile Storage Device

18W
**G20T/V20T/
X20T Series:**

G STB
(机顶盒)

V Netcom
(网通)

X Security
(安防)



| Model | T (V) | Voltage (V) | Current (A) | Ripple (mV) | Power Max(w) | Efficiency (V/ VI) |
|----------------------|-----------|----------------|----------------|----------------|-----------------|-----------------------|
| MSS-V1500WR120-01810 | T1: 9-12V | 12 | 1.5 | 120 | 18 | VI |

Adapter, Wall-mount

Input Voltage: 90~264Vac / 47~63Hz

Input Current: <0.6A

Start Inrush Current: 80Amax.

Surge: CM/DM: 6KV max

Protection: OCP, SCP, OVP

Y Cap: With Y-cap

LED Display: No

Product Type: Vertical

AC Plug: US, DE, GB, AU, KR

Dimension: 73.5*33*60.9mm

Working Temperature: 0~45°C

Safety: CCC, CE, CB, UL, FCC, GS, BSMI(5V), SAA, RCM, KC(12V), PSE, PSB(12V)

Application: Set Top Box, ADSL Gateway

Ready to be taken off the shelves
(即将下架)

18W
G20/ V20
Series:

G STB
(机顶盒)

V Netcom
(网通)



| Model | T (V) | Voltage (V) | Current (A) | Ripple (mV) | Power Max(w) | Efficiency (V/VI) |
|---------------------|------------|-------------|-------------|-------------|--------------|-------------------|
| MSP-C3000IC5.0-18A | T1: 5-7.5V | 5 | 3.0 | 120 | 15 | VI |
| MSP-C1500IC12.0-18A | T2: 9-15V | 12 | 1.5 | 120 | 18 | VI |

Adapter, Wall-mount

Input Voltage: 90~264Vac / 47~63Hz

Input Current: <0.7A

Start Inrush Current: 80Amax.

Surge: CM/DM: 6KV max

Protection: OCP, SCP, OVP

Y Cap: No Y-cap

LED Display: No

Product Type: Horizontal

AC Plug: CN, US, DE, KR, GB, AU, IN

Dimension: 77*45.5*31.5mm

Working Temperature: 0~45°C

Safety: CCC, CE, CB, UL, FCC, UKCA,
SAA, RCM, NOM(12V), BIS(12V)

Application: ADSL Gateway, Netcom

18W
V20
Series:

V Netcom
(网通)

Ready to be taken off the shelves
(即将下架)



| Model | T (V) | Voltage (V) | Current (A) | Ripple (mV) | Power Max(w) | Efficiency (V/ VI) |
|---------------------|-----------|----------------|----------------|----------------|-----------------|-----------------------|
| MSA-C1500CS12.0-18J | T1: 5-15V | 12 | 1.5 | 120 | 18 | VI |

Adapter, Wall-mount

Input Voltage: 90~264Vac / 47~63Hz

Input Current: <0.7A

Start Inrush Current: 80Amax.

Surge: CM: 4KV max; DM: 2KV max

3.2A peak load for 10S

Protection: OCP, SCP, OVP

Y Cap: With Y-cap

LED Display: No

Product Type: Horizontal

AC Plug: CN, US, DE, GB, IN

Dimension: 86*37.5*36.2mm

Working Temperature: 0~45°C

Safety: CCC, CE, CB, UKCA, FCC, UL, BIS

Application: Set Top Box, ADSL Gateway,
Security Monitoring, Mobile Storage Device

24W
G30/ V30/ X30
Series:

G STB
(机顶盒)

V Netcom
(网通)

X Security
(安防)



| Model | T (V) | Voltage (V) | Current (A) | Ripple (mV) | Power Max(w) | Efficiency (V/VI) |
|--------------------|-----------|----------------|----------------|----------------|-----------------|----------------------|
| MS-H1500R120-018M0 | T1: 9-12V | 12 | 1.5 | 150 | 18 | VI |
| MS-H2000R120-024K0 | T1: 9-12V | 12 | 2.0 | 180 | 24 | VI |

Adapter, Wall-mount

Input Voltage: 90~264Vac / 47~63Hz

Input Current: <0.7A

Start Inrush Current: 80Amax.

Surge: CM/DM: 6KV max

Protection: OCP, SCP, OVP

Y Cap: With Y-cap

LED Display: No

Product Type: Horizontal

AC Plug: CN, US, DE, KR, GB, BR, AU, IN

Dimension: 77*45.5*31.5mm

Working Temperature: 0~45°C

Safety: CCC, CE, CB, GS, UL, FCC, U.K.A, S-mark(5V),
PSE, SAA, BIS(5V,9V), NOM(12V), UAE, EAC, KC

Application: Set Top Box, ADSL Gateway,
Security Monitoring, Mobile Storage Device

18W
G20/ V20/ X20
Series:

G STB
(机顶盒)

V Netcom
(网通)

X Security
(安防)

Ready to be taken off the shelves
(即将下架)



| Model | T (V) | Voltage (V) | Current (A) | Ripple (mV) | Power Max(w) | Efficiency (V/VI) |
|---------------------|------------|----------------|----------------|----------------|-----------------|----------------------|
| MSA-C3000IC5.0-18P | T1: 5-8.9V | 5 | 3.0 | 120 | 15 | VI |
| MSA-C2000IC9.0-18P | T2: 9-12V | 9 | 2.0 | 120 | 18 | VI |
| MSA-C1500IC12.0-18P | | 12 | 1.5 | 120 | 18 | VI |

Adapter, Wall-mount

Input Voltage: 90~264Vac / 47~63Hz

Input Current: <0.7A

Start Inrush Current: 80Amax.

Surge: CM/DM: 6KV max

Protection: OCP, SCP, OVP

Y Cap: With Y-cap

LED Display: No

Product Type: Horizontal

AC Plug: CN, US, DE, KR, GB, BR, AU, IN

Dimension: 77*45.5*31.5mm

Working Temperature: 0~45°C

Safety: CCC, CE, CB, GS, UL, FCC, U.K.A,
S-mark, PSE, SAA, BIS, NOM, UAE, EAC, KC

Application: Set Top Box, ADSL Gateway,
Security Monitoring, Mobile Storage Device

24W
G20/ V20/ X20
Series:

G STB
(机顶盒)

V Netcom
(网通)

X Security
(安防)

Ready to be taken off the shelves
(即将下架)



| Model | T (V) | Voltage (V) | Current (A) | Ripple (mV) | Power Max(w) | Efficiency (V/VI) |
|---------------------|------------|----------------|----------------|----------------|-----------------|----------------------|
| MSA-C3500IC5.0-24P | T1: 5-8.9V | 5 | 3.0 | 120 | 17.5 | VI |
| MSA-C2500IC9.0-24P | T2: 9-12V | 9 | 2.5 | 120 | 22.5 | VI |
| MSA-C2000IC12.0-24P | | 12 | 2.0 | 120 | 24 | VI |
| MSA-C1000IC24.0-24P | T3: 19-24V | 24 | 1.0 | 120 | 24 | VI |

Adapter, Wall-mount

Input Voltage: 90~264Vac / 47~63Hz

Input Current: <0.7A

Start Inrush Current: 80Amax.

Surge: CM/DM: 6KV max, K.21+

Protection: OCP, SCP, OVP

Y Cap: Optional

LED Display: Yes

Product Type: Vertical or Horizontal

AC Plug: CN, US, JP, DE, KR, GB, AU

Dimension: 74*32*42mm (Vertical type)
& 77*45.5*31.5mm (Horizontal type)

Working Temperature: 0~45°C

Safety: CCC, CE, CB, UL, FCC, UKCA

Application: Set Top Box, ADSL Gateway,
Security Monitoring, Mobile Storage Device

24W
G30/ V30
Series:

G STB
(机顶盒)

V Netcom
(网通)



| Model | T (V) | Voltage (V) | Current (A) | Ripple (mV) | Power Max(w) | Efficiency (V/VI) |
|--------------------|-----------|-------------|-------------|-------------|--------------|-------------------|
| MS-V2500R090-024Q0 | T1: 9-15V | 9 | 2.5 | 120 | 18 | VI |
| MS-V2000R120-024Q0 | | 12 | 2.0 | 120 | 24 | VI |
| MS-V1600R150-024Q0 | | 15 | 1.6 | 120 | 24 | VI |

Adapter, Wall-mount

Input Voltage: 90~264Vac / 47~63Hz

Input Current: <0.7A

Start Inrush Current: 80Amax.

Surge: CM/DM: 6KV max, K.21+

Protection: OCP, SCP, OVP

Y Cap: With Y-cap

LED Display: No

Product Type: Horizontal

AC Plug: CN, US, DE, GB

Dimension: 77*45.5*31.5mm

Working Temperature: 0~45°C

Safety: CCC, CE, CB, UKCA, FCC

Application: ADSL Gateway, Netcom

24W

V20

Series:

V Netcom
(网通)

Ready to be taken off the shelves
(即将下架)



| Model | T (V) | Voltage (V) | Current (A) | Ripple (mV) | Power Max(w) | Efficiency (V/VI) |
|---------------------|------------|-------------|-------------|-------------|--------------|-------------------|
| MSA-C2000IC12.0-24J | T1: 9-16V | 12 | 2.0 | 120 | 24 | VI |
| MSA-C1000IC24.0-24J | T2: 18-24V | 24 | 1.0 | 120 | 24 | VI |

Adapter, Wall-mount

Input Voltage: 90~264Vac / 47~63Hz

Input Current: <0.7A

Start Inrush Current: 80Amax.

Surge: CM/DM: 6KV max

Protection: OCP, SCP, OVP

Y Cap: With Y-cap

LED Display: Yes

Product Type: Vertical

AC Plug: US, DE, GB, AU

Dimension: 73.5*33*60.9mm

Working Temperature: 0~45°C

Safety: CE, CB, UL, FCC, BSMI(12V)

Application: Set Top Box, ADSL Gateway,
Mobile Storage Device

24W

G30/ V30

Series:

G STB
(机顶盒)

V Netcom
(网通)



| Model | T (V) | Voltage (V) | Current (A) | Ripple (mV) | Power Max(w) | Efficiency (V/VI) |
|--------------------|------------|-------------|-------------|-------------|--------------|-------------------|
| MS-V2000R120-024H0 | T1: 9-12V | 12 | 2.0 | 120 | 24 | VI |
| MS-V1000R240-024H0 | T1: 19-24V | 24 | 1.0 | 120 | 24 | VI |

Adapter, Wall-mount

Input Voltage: 90~264Vac / 47~63Hz

Input Current: <0.7A

Start Inrush Current: 80Amax.

Surge: CM: 6KV max; DM: 6KV max

Protection: OCP, SCP, OVP

Y Cap: With Y-cap

LED Display: Yes

Product Type: Vertical

AC Plug: US, DE, GB, AU

Dimension: 84*32*46mm

Working Temperature: 0~45°C

Safety: CE, CB, UL, FCC, UKCA, NOM

Application: Set Top Box, ADSL Gateway, Security Monitoring, Mobile Storage Device

**Ready to be taken off the shelves
(即将下架)**

24W
**G20T/V20T/
X20T Series:**

G STB
(机顶盒)

V Netcom
(网通)

X Security
(安防)



| Model | T (V) | Voltage (V) | Current (A) | Ripple (mV) | Power Max(w) | Efficiency (V/ VI) |
|--------------------|-----------|-------------|-------------|-------------|--------------|--------------------|
| MS-V2000R120-024E0 | T1: 9-12V | 12 | 2.0 | 120 | 24 | VI |

Adapter, Desktop

Input Voltage: 90~264Vac / 47~63Hz

Input Current: <0.7A

Start Inrush Current: 50Amax.

Surge: CM/DM: 4KV max

Protection: OCP, SCP, OVP

Y Cap: With Y-cap

LED Display: No

Product Type: Desktop

Socket: 2PIN (C8)

Dimension: 93.3*40*31mm

Working Temperature: 0~40°C

Safety: CE, CB, CCC

Application: Set Top Box, ADSL Gateway,
Mobile Storage Device

24W

G30/ V30

Series:

G STB
(机顶盒)

V Netcom
(网通)



| Model | T (V) | Voltage (V) | Current (A) | Ripple (mV) | Power Max(w) | Efficiency (V/ VI) |
|----------------------|-----------|----------------|----------------|----------------|-----------------|-----------------------|
| MSA-Z2000WR120-024B0 | T1: 8-12V | 12 | 2.0 | 120 | 24 | VI |
| MSA-Z2000IC12.0-24W | T1: 8-12V | 12 | 2.0 | 120 | 24 | VI |

Adapter, Wall-mount

Input Voltage: 90~264Vac / 47~63Hz

Input Current: <1.0A

Start Inrush Current: 80Amax.

Surge: CM: 6KV max; DM: 6KV max

Protection: OCP, SCP, OVP

Y Cap: With Y-cap

LED Display: Yes

Product Type: Vertical

AC Plug: US, DE, GB, AU

Dimension: 73.5*33*60.9mm

Working Temperature: 0~40°C

Safety: CE, CB, UL, FCC, UKCA

Application: Set Top Box, ADSL Gateway,
Mobile Storage Device

30W

G30/ V30

Series:

G STB
(机顶盒)

V Netcom
(网通)



| Model | T (V) | Voltage (V) | Current (A) | Ripple (mV) | Power Max(w) | Efficiency (V/ VI) |
|--------------------|-----------|----------------|----------------|----------------|-----------------|-----------------------|
| MS-V2500R120-030H0 | T1: 9-15V | 12 | 2.5 | 120 | 30 | VI |

Adapter, Wall-mount

Input Voltage: 90~264Vac / 47~63Hz

Input Current: <1.0A

Start Inrush Current: 80Amax.

Surge: CM/DM: 6KV max; K.21+

Protection: OCP, SCP, OVP

Y Cap: With Y-cap

LED Display: Yes

Product Type: Vertical

AC Plug: US, DE, GB, AU

Dimension: 84*32*46mm

Working Temperature: 0~45°C

Safety: CE, CB, UL, FCC, UKCA, N-mark, SAA

Application: Set Top Box, ADSL Gateway,
Mobile Storage Device

30W
G20T/ V20T
Series:

G STB
(机顶盒)

V Netcom
(网通)



| Model | T (V) | Voltage (V) | Current (A) | Ripple (mV) | Power Max(w) | Efficiency (V/ VI) |
|--------------------|-----------|----------------|----------------|----------------|-----------------|-----------------------|
| MS-V2500R120-030E0 | T1: 9-15V | 12 | 2.5 | 120 | 30 | VI |

Adapter, Wall-mount

Input Voltage: 90~264Vac / 47~63Hz

Input Current: <1.0A

Start Inrush Current: 80Amax.

Surge: CM/DM: 6KV max; K.21+

Protection: OCP, SCP, OVP

Y Cap: No Y-cap

LED Display: Yes

Product Type: Vertical

AC Plug: US, DE, GB, AU

Dimension: 84*32*46mm

Working Temperature: 0~45°C

Safety: CE, CB

Application: ADSL Gateway

30W
V30
Series:

V Netcom
(网通)



| Model | T (V) | Voltage (V) | Current (A) | Ripple (mV) | Power Max(w) | Efficiency (V/ VI) |
|--------------------|-----------|----------------|----------------|----------------|-----------------|-----------------------|
| MS-V2500R120-030E1 | T1: 9-15V | 12 | 2.5 | 120 | 30 | VI |

Adapter, Outdoor IP67

Input Voltage: 90~264Vac / 47~63Hz

Input Current: <1.2A

Start Inrush Current: 100A max

Surge: CM: 4KV max; DM: 2KV max

Waterproof and dustproof: IP67

Protection: OCP, SCP, OVP

Y Cap: With Y-cap

LED Display: No

Product Type: Metal Case

Socket: 2PIN with AC cable

Dimension: 102*64*33mm

Working Temperature: -20~55°C

Safety: CB, UL, FCC

Application: ADSL Gateway, Netcom

30W

V30

Series:

V

Netcom
(网通)



| Model | T (V) | Voltage (V) | Current (A) | Ripple (mV) | Power Max(w) | Efficiency (V/ VI) |
|--------------------|-----------|----------------|----------------|----------------|-----------------|-----------------------|
| MS-T2500R120-030N0 | T1: 9-12V | 12 | 2.5 | 240 | 30 | VI |

Adapter, Wall-mount

Input Voltage: 90~264Vac / 47~63Hz

Input Current: <1.0A

Start Inrush Current: 80Amax.

Surge: CM: 6KV max; DM: 6KV max

Protection: OCP, SCP, OVP

Y Cap: With Y-cap

LED Display: Yes

Product Type: Vertical

AC Plug: US, DE, GB, AU

Dimension: 91*33.5*56.5mm

Working Temperature: 0~45°C

Safety: CE, CB, UL, FCC, UKCA

Application: Set Top Box, ADSL Gateway,
Security Monitoring, Mobile Storage Device

36W
G30/ V30/ X30
Series:

G STB
(机顶盒)

V Netcom
(网通)

X Security
(安防)



| Model | T (V) | Voltage (V) | Current (A) | Ripple (mV) | Power Max(w) | Efficiency (V/ VI) |
|--------------------|-----------|----------------|----------------|----------------|-----------------|-----------------------|
| MS-V3000R120-036H0 | T1: 9-12V | 12 | 3.0 | 120 | 36 | VI |
| MS-V3000R120-036I0 | T1: 9-15V | 12 | 3.0 | 120 | 36 | VI |

Adapter, Wall-mount

Input Voltage: 90~264Vac / 47~63Hz

Input Current: <1.0A

Start Inrush Current: 100Amax.

Surge: CM/DM: 6KV max; K.21+

Protection: OCP, SCP, OVP

Y Cap: With Y-cap

LED Display: Yes

Product Type: Vertical

AC Plug: US, DE, GB, AU

Dimension: 91*33.5*56.5mm

Working Temperature: 0~45°C

Safety: CE, CB, SAA, RCM

Application: Set Top Box, ADSL Gateway,
Mobile Storage Device

36W
G20T/ V20T
Series:

G STB
(机顶盒)

V Netcom
(网通)



| Model | T (V) | Voltage (V) | Current (A) | Ripple (mV) | Power Max(w) | Efficiency (V/ VI) |
|---------------------|-----------|----------------|----------------|----------------|-----------------|-----------------------|
| MS-V3000WR120-036E0 | T1: 9-15V | 12 | 3.0 | 120 | 36 | VI |

Adapter, Wall-mount

Input Voltage: 90~264Vac / 47~63Hz

Input Current: <1.0A

Start Inrush Current: 100Amax.

Surge: CM: 6KV max; DM: 6KV max

Protection: OCP, SCP, OVP

Y Cap: No Y-cap

LED Display: Yes

Product Type: Vertical

AC Plug: US, DE, GB, AU

Dimension: 91*33.5*56.5mm

Working Temperature: 0~45°C

Safety: SAA, RCM

Application: ADSL Gateway, Netcom

36W

V30

Series:

V Netcom
(网通)



| Model | T (V) | Voltage (V) | Current (A) | Ripple (mV) | Power Max(w) | Efficiency (V/ VI) |
|--------------------|-----------|----------------|----------------|----------------|-----------------|-----------------------|
| MS-V3000R120-036L0 | T1: 9-15V | 12 | 3.0 | 200 | 36 | VI |

Adapter, Wall-mount

Input Voltage: 90~264Vac / 47~63Hz

Input Current: <1.0A

Start Inrush Current: 100Amax.

Surge: CM: 2KV max; DM: 1KV max

Protection: OCP, SCP, OVP

Y Cap: With Y-cap

LED Display: Yes

Product Type: Horizontal

AC Plug: DE, US

Dimension: 95.5*47*32.5mm

Working Temperature: -10~45°C

Safety: CE, CB

Application: ADSL Gateway, Netcom

36W

V30

Series:

V Netcom
(网通)



| Model | T (V) | Voltage (V) | Current (A) | Ripple (mV) | Power Max(w) | Efficiency (V/ VI) |
|--------------------|----------|------------------------|----------------|----------------|-----------------|-----------------------|
| MS-H2400R150-036P1 | - | 5V/3A, 9V/3A, 15V/2.4A | | 120 | 36 | VI |

Adapter, Desktop

Input Voltage: 90~264Vac / 47~63Hz

Input Current: <1.0A

Start Inrush Current: 100Amax.

Surge: CM: 4KV max; DM: 2KV max

Protection: OCP, SCP, OVP

Y Cap: With Y-cap

LED Display: Yes

Product Type: Desktop

Socket: 2PIN&3PIN (C6, C8)

Dimension: 105*45*30mm

Working Temperature: 0~45°C

Safety: CE, CB, GS, BIS, S-mark

Application: Set Top Box, ADSL Gateway,
Security Monitoring, Mobile Storage Device

36W
G20T/V20T/X20T
Series:

G STB
(机顶盒)

V Netcom
(网通)

X Security
(安防)



| Model | T (V) | Voltage (V) | Current (A) | Ripple (mV) | Power Max(w) | Efficiency (V/ VI) |
|-----------------------|-----------|----------------|----------------|----------------|-----------------|-----------------------|
| MSA-Z3000IC12.0-036B0 | T1: 8-15V | 12 | 3.0 | 120 | 36 | VI |

Adapter, Desktop

Input Voltage: 90~264Vac / 47~63Hz

Input Current: <1.5A

Start Inrush Current: 100Amax.

Surge: CM: 4KV max; DM: 4KV max

Protection: OCP, SCP, OVP

Y Cap: With Y-cap

LED Display: No

Product Type: Desktop

Socket: 2PIN (C8)

Dimension: 110*49.5*27mm

Working Temperature: 0~45°C

Safety: CCC, CE, CB, UL, FCC, PSE,
UKCA, SAA, KC, NOM, BSMI, PSB

Application: Displayer, Audio and Video Player

38W

H30

Series:

H

 Stereo
(音响)

| Model | T (V) | Voltage (V) | Current (A) | Ripple (mV) | Power Max(w) | Efficiency (V/ VI) |
|--------------------|------------|----------------|----------------|----------------|-----------------|-----------------------|
| MS-Z1520R250-038A0 | T1: 18-25V | 25 | 1.52 | 250 | 38 | VI |

Adapter, Wall-mount

Input Voltage: 90~264Vac / 47~63Hz

Input Current: <1.2A

Start Inrush Current: 100Amax.

Surge: CM: 4KV max; DM: 4KV max

Protection: OCP, SCP, OVP

Y Cap: With Y-cap

LED Display: Yes

Product Type: Vertical

AC Plug: US, DE, GB, AG, AU

Dimension: 91*33.5*56.5mm

Working Temperature: 0~45°C

Safety: CE, CB, UL, FCC, S-mark

Application: Set Top Box, ADSL Gateway,
Mobile Storage Device

Has been taken off the shelves
(即将下架)



40W

G20/V20

Series:

G

STB
(机顶盒)

V

Netcom
(网通)



| Model | T (V) | Voltage (V) | Current (A) | Ripple (mV) | Power Max(w) | Efficiency (V/ VI) |
|---------------------|-----------|----------------|----------------|----------------|-----------------|-----------------------|
| MSA-C3330IS12.0-40X | T1: 8-12V | 12 | 3.33 | 120 | 40 | VI |

Adapter, Wall-mount

Input Voltage: 90~264Vac / 47~63Hz

Input Current: <1.2A

Start Inrush Current: 100Amax.

Surge: CM: 6KV max; DM: 6KV max

Protection: OCP, SCP, OVP

Y Cap: With Y-cap

LED Display: Yes

Product Type: Vertical

AC Plug: US, DE, GB, AG, AU

Dimension: 91*33.5*56.5mm

Working Temperature: 0~45°C

Safety: CE, CB, UL, FCC, UKCA, SAA,
RCM, NOM, BSMI, IRAM

Application: Set Top Box, ADSL Gateway,
Mobile Storage Device

42W
G20T/V20T
Series:

G STB
(机顶盒)

V Netcom
(网通)



| Model | T (V) | Voltage (V) | Current (A) | Ripple (mV) | Power Max(w) | Efficiency (V/ VI) |
|----------------------|-----------|----------------|----------------|----------------|-----------------|-----------------------|
| MSS-V3500WR120-042A0 | T1: 8-12V | 12 | 3.5 | 120 | 42 | VI |

Adapter, Desktop

Input Voltage: 90~264Vac / 47~63Hz

Input Current: <1.2A

Start Inrush Current: No damage

Surge: CM: 4KV max; DM: 2KV max

Peak load: 6.2A for 10S

Protection: OCP, SCP, OVP

Y Cap: With Y-cap

LED Display: Yes

Product Type: Desk-top

Socket: 3PIN (C6, C14)

Dimension: 116*52.4*31.3mm

Working Temperature: -20~45°C

Safety: CCC, CE, CB, UL, FCC, UKCA, BIS

Application: Set Top Box, ADSL Gateway,
Security Monitoring, Mobile Storage Device

40W
X30
Series:

X Security
(安防)



| Model | T (V) | Voltage (V) | Current (A) | Ripple (mV) | Power Max(w) | Efficiency (V/ VI) |
|--------------------|-----------|----------------|------------------------|----------------|-----------------|-----------------------|
| MS-Z3330R120-048D0 | T1: 9-12V | 12.0 | 3.33 (6.2A for 10S) | 150 | 40 | VI |

Adapter, Wall-mount

Input Voltage: 90~264Vac / 47~63Hz

Input Current: <1.5A

Start Inrush Current: No damage

Surge: CM: 4KV max; DM: 2KV max

Protection: OCP, SCP, OVP

Y Cap: With Y-cap

LED Display: No

Product Type: Vertical

AC Plug: US & DE

Dimension: 91*33.5*69.5mm

Working Temperature: 0~45°C

Safety: CCC, CE, CB, GS, UL, FCC,
EAC, KC, NOM

Application: Displayer, Monitor,
Audio and Video Player

48W

A30

Series:

A Display &
projector
(显示投影)



| Model | T (V) | Voltage (V) | Current (A) | Ripple (mV) | Power Max(w) | Efficiency (V/ VI) |
|--------------------|------------|----------------|----------------|----------------|-----------------|-----------------------|
| MS-V2530R190-048L0 | T1: 18-24V | 19 | 2.53 | 200 | 48 | VI |

Adapter, Desktop

Input Voltage: 90~264Vac / 47~63Hz

Input Current: <1.2A

Start Inrush Current: 100Amax.

Surge: CM: 4KV max; DM: 4KV max

Protection: OCP, SCP, OVP

Y Cap: With Y-cap

LED Display: Yes

Product Type: Desktop

Socket: 2PIN&3PIN (C6, C8, C14)

Dimension: 114*54*37mm

Working Temperature: 0~45°C

Safety: CCC, CE, CB, UL, FCC, GS, UKCA, KC, BIS, BSMI, NOM, S-mark

Application: Set Top Box, ADSL Gateway, Security Monitoring, Mobile Storage Device

48W
G20/ V20/ A20
/X20 Series:

G STB
(机顶盒)

V Netcom
(网通)

A Display & projector
(显示投影)

X Security
(安防)

Has been taken off the shelves
(即将下架)



| Model | T (V) | Voltage (V) | Current (A) | Ripple (mV) | Power Max(w) | Efficiency (V/VI) |
|---------------------|-----------|-------------|-------------|-------------|--------------|-------------------|
| MSA-Z4000IC12.0-48W | T1: 10-15 | 12 | 4 | 120 | 48 | VI |
| MSA-Z2500IC19.0-48W | T2: 19-24 | 19 | 2.5 | 200 | 48 | VI |
| MSA-Z2000IC24.0-48W | | 24 | 2.0 | 240 | 48 | VI |

Adapter, Desktop

Input Voltage: 90~264Vac / 47~63Hz

Input Current: <1.2A

Start Inrush Current: 100Amax.

Surge: CM: 4KV max; DM: 4KV max

Protection: OCP, SCP, OVP

Y Cap: With Y-cap

LED Display: Yes

Product Type: Desktop

Socket: 2PIN&3PIN (C6, C8, C14)

Dimension: 114*54*37mm

Working Temperature: 0~45°C

Safety: CE, CB, KC, SAA, BSMI

Application: Set Top Box, ADSL Gateway,
Mobile Storage Device

48W
G20T/V20T
Series:

G STB
(机顶盒)

V Netcom
(网通)

A Display &
projector
(显示投影)

Has been taken off the shelves
(即将下架)



| Model | T (V) | Voltage (V) | Current (A) | Ripple (mV) | Power Max(w) | Efficiency (V/VI) |
|---------------------|-----------|-------------|-------------|-------------|--------------|-------------------|
| MSA-Z4000IC12.0-48E | T1: 10-15 | 12 | 4 | 120 | 48 | VI |
| MSA-Z2500IC19.0-48E | T2: 19-24 | 19 | 2.5 | 200 | 47.5 | VI |
| MSA-Z2000IC24.0-48E | | 24 | 2.0 | 240 | 48 | VI |

Adapter, Desktop

Input Voltage: 90~264Vac / 47~63Hz

Input Current: <1.2A

Start Inrush Current: 100Amax.

Surge: CM: 4KV max; DM: 4KV max

Protection: OCP, SCP, OVP

Y Cap: With Y-cap

LED Display: Yes

Product Type: Desktop

Socket: 2PIN&3PIN (C6, C8, C14)

Dimension: 116*52.4*31.3mm

Working Temperature: 0~45°C

Safety: CCC, CE, CB, UL, FCC

Application: Set Top Box, ADSL Gateway,
Mobile Storage Device

48W
V30 Series:



G STB
(机顶盒)

V Netcom
(网通)

A Display &
projector
(显示投影)

**Under
development**
(开发中)



| Model | T (V) | Voltage (V) | Current (A) | Ripple (mV) | Power Max(w) | Efficiency (V/VI) |
|---------------------|-----------|----------------|----------------|----------------|-----------------|----------------------|
| V30-Z4000R120-048F0 | T1: 10-15 | 12 | 4 | 120 | 48 | VI |
| V30-Z2500R190-048F0 | T2: 19-24 | 19 | 2.5 | 200 | 48 | VI |
| V30-Z2000R240-048F0 | | 24 | 2.0 | 240 | 48 | VI |

Adapter, Desktop

Input Voltage: 90~264Vac / 47~63Hz

Input Current: <1.5A

Start Inrush Current: No damage

Surge: CM: 4KV max; DM: 2KV max

Protection: OCP, SCP, OVP

Y Cap: With Y-cap

LED Display: No

Product Type: Desk-top

Socket: 3PIN (C6)

Dimension: 115*52*28.3mm

Working Temperature: 0~40°C

Safety: CCC, CE, CB, UL, FCC, UKCA,
EAC, NOM, KC, SAA, IRAM, PSE, BSMI

Application: Displayer, Monitor,
Audio and Video Player

48W

A30

Series:

A Display &
projector
(显示投影)



| Model | T (V) | Voltage (V) | Current (A) | Ripple (mV) | Power Max(w) | Efficiency (V/ VI) |
|--------------------|------------|----------------|----------------|----------------|-----------------|------------------------|
| MS-Z2530R190-048M0 | T2: 18-24V | 19.0 | 2.53 | 200 | 48 | VI |

Adapter, Desktop

Input Voltage: 90~264Vac / 47~63Hz

Input Current: <1.2A

Start Inrush Current: No damage

Surge: CM: 4KV max; DM: 2KV max

Protection: OCP, SCP, OVP

Y Cap: With Y-cap

LED Display: Yes

Product Type: Desk-top

Socket: 3PIN (C6, C14)

Dimension: 116*52.4*31.3mm

Working Temperature: 0~40°C

Safety: CCC, CE, CB, UL, FCC, UKCA, BIS

Application: ADSL Gateway, Security Monitor

48W

X30

Series:

X Security
(安防)



| Model | T (V) | Voltage (V) | Current (A) | Ripple (mV) | Power Max(w) | Efficiency (V/ VI) |
|--------------------|------------|----------------|----------------|----------------|-----------------|-----------------------|
| MS-Z1040R480-048G0 | T1: 42-48V | 48.0 | 1.04 | 300 | 48 | VI |

Adapter, Wall-mount

Input Voltage: 90~264Vac / 47~63Hz

Input Current: <1.3A

Start Inrush Current: 100Amax.

Surge: CM: 6KV max; DM: 6KV max

Protection: OCP, SCP, OVP

Y Cap: With Y-cap

LED Display: Yes

Product Type: Vertical

AC Plug: US, DE, GB

Dimension: 91*33.5*56.5mm

Working Temperature: 0~45°C

Safety: CE, CB, UL, FCC

Application: Set Top Box, ADSL Gateway,
Mobile Storage Device

50W

G30/ V30

Series:

G STB
(机顶盒)

V Netcom
(网通)



| Model | T (V) | Voltage (V) | Current (A) | Ripple (mV) | Power Max(w) | Efficiency (V/ VI) |
|--------------------|-----------|----------------|----------------|----------------|-----------------|-----------------------|
| MS-V4100R120-050A0 | T1: 9-15V | 12 | 4.1 | 120 | 49.2 | VI |

Adapter, Desktop

Input Voltage: 90~264Vac / 47~63Hz

Input Current: <1.5A

Start Inrush Current: No damage

Surge: CM: 4KV max; DM: 4KV max

Peak load: 4.8A for 10S

Protection: OCP, SCP, OVP

Y Cap: With Y-cap

LED Display: No

Product Type: Desk-top

Socket: 2PIN (C8)

Dimension: 116*52.5*33mm

Working Temperature: 0~40°C

Safety: CCC, CE, CB, UL, FCC, UKCA,
GS, EAC, NOM, KC, SAA, PSE, BSMI

Application: Displayer, Monitor,
Audio and Video Player

| Model | T (V) | Voltage (V) | Current (A) | Ripple (mV) | Power Max(w) | Efficiency (V/ VI) |
|--------------------|------------|----------------|-----------------------|----------------|-----------------|------------------------|
| MS-Z2000R250-050D0 | T1: 18-25V | 25.0 | 2.0 (4.8A for 10S) | 250 | 50 | VI |

50W

H30

Series:

H

 Stereo
(音响)

Adapter, Wall-mount(家电类)

Input Current: <1.5A@110Vac
Start Inrush Current: No damage
Surge: CM: 2KV max, DM: 1KV max
Peak Power: 150W
Protection: OCP, SCP, OVP

Y Cap: With double Y-cap
LED Display: Yes
Product Type: Horizontal
AC Plug: US

Dimension: 100*49*36mm
Working Temperature: 0~40°C
Safety: UL

Application: Electric lifting platform

58W
D30
Series:

D Motor
 Drive
 (电机驱动)

NEW
 (新品)



| Model | T (V) | Voltage (V) | Current (A) | Ripple (mV) | Power Max(w) | Efficiency (V/ VI) |
|--------------------|----------|----------------|----------------|----------------|-----------------|------------------------|
| MS-H2000R290-058G0 | T1: 29V | 29 | 2.0 | 380 | 58 | VI |

Adapter, Desktop(家电类/医疗)

Input Current: <1.5A@110Vac
Start Inrush Current: No damage
Surge: CM: 2KV max, DM: 1KV max
Peak Power: 150W
Protection: OCP, SCP, OVP

Y Cap: With double Y-cap
LED Display: Yes
Product Type: Horizontal
AC Plug: US

Dimension: 123*53*36mm
Working Temperature: 0~40°C
Safety: TUV,SAA

Application: Electric lifting platform

58W

D30
Series:

D Motor Drive
(电机驱动)

NEW
(新品)



| Model | T (V) | Voltage (V) | Current (A) | Ripple (mV) | Power Max(w) | Efficiency (V/ VI) |
|--------------------|---------|-------------|-------------|-------------|--------------|--------------------|
| MS-H2000R290-058H0 | T1: 29V | 29 | 2.0 | 380 | 58 | VI |

Adapter, Desktop

Input Voltage: 90~264Vac / 47~63Hz

Input Current: <1.5A

Start Inrush Current: 100Amax.

Surge: CM: 6KV max; DM: 6KV max

Protection: OCP, SCP, OVP

Y Cap: With Y-cap

LED Display: Yes

Product Type: Desktop

Socket: 2PIN&3PIN (C6, C8, C14)

Dimension: 116*52.5*33mm

Working Temperature: 0~40°C

Safety: CCC, CE, CB, UL, FCC

Application: Set Top Box, ADSL Gateway, Displayer, Monitor, Audio and Video Player, Printer

60W
G30/ V30/ A30/
X30
Series:



G STB
(机顶盒)

V Netcom
(网通)

A Display &
projector
(显示投影)

X Security
(安防)

M Business
printer
(商用打印)



| Model | T (V) | Voltage (V) | Current (A) | Ripple (mV) | Power Max(w) | Efficiency (V/VI) |
|--------------------|-------------|----------------|----------------|----------------|-----------------|----------------------|
| MS-Z5000R120-060B0 | T1: 9-16 | 12.0 | 5.0 | 200 | 60 | VI |
| MS-Z3420R190-060B0 | T2: 16.1-30 | 19.0 | 3.42 | 200 | 65 | VI |
| MS-Z2700R240-060B0 | | 24.0 | 2.7 | 200 | 65 | VI |
| MS-Z1250R480-060B0 | T3: 30.1-48 | 48.0 | 1.25 | 300 | 60 | VI |

Adapter, Outdoor IP65

Input Voltage: 90~264Vac / 47~63Hz

Input Current: <1.5A

Start Inrush Current: No damage.

Surge: CM: 6KV max; DM: 4KV max

Protection: OCP, SCP, OVP

Waterproof and dustproof: IP65

Y Cap: With Y-cap

LED Display: No

Product Type: Metal Case

Socket: 3PIN with AC cable

Dimension: 130*55*35.1mm

Working Temperature: -40~70°C

Safety: CCC

Application: Security Monitoring

60W
X30
Series:

X Security
(安防)



| Model | T (V) | Voltage (V) | Current (A) | Ripple (mV) | Power Max(w) | Efficiency (V/ VI) |
|--------------------|------------|-------------|-------------|-------------|--------------|---------------------|
| MS-H1670R360-060D0 | T1: 30-36V | 36 | 1.67A | 1080 | 60 | VI |

Adapter, Desktop

Input Voltage: 90~264Vac / 47~63Hz

Input Current: <1.8A

Start Inrush Current: No damage

Surge: CM: 4KV max; DM: 2KV max

Peak load: 6.2A for 10S

Protection: OCP, SCP, OVP

Y Cap: With Y-cap

LED Display: Yes

Product Type: Desktop

Socket: 3PIN (C6, C14)

Dimension: 123.1*58*33.6mm

Working Temperature: 0~40°C

Safety: CCC, CE, CB, UL, FCC, BIS,
UKCA

Application: ADSL Gateway,
Security Monitoring, Mobile Storage Device

60W
G30/ V30/ X30
Series:

X Security
(安防)



| Model | T (V) | Voltage (V) | Current (A) | Ripple (mV) | Power Max(w) | Efficiency (V/ VI) |
|--------------------|-----------|----------------|-----------------------|----------------|-----------------|-----------------------|
| MS-Z5000R120-065D0 | T1: 9-12V | 12 | 5.0 (6.2A for 10S) | 150 | 60 | VI |

Adapter, Desktop

Input Voltage: 90~264Vac / 47~63Hz
Input Current: <1.5A
Start Inrush Current: No damage.
Surge: CM: 4KV max; DM: 2KV max
Peak load> 11A
Protection: OCP, SCP, OVP

Y Cap: With Y-cap
LED Display: Yes
Product Type: Desktop
Socket: 3PIN (C14)

Dimension: 130*57*36mm
Working Temperature: 0~40°C
Safety: CCC, CE, CB, GS, UKCA, UL,
 FCC, PSE, BIS, KC, IRAM, SAA, PSB

Application: Printer

60W
M20
Series:

M Business printer
 (商用打印)



| Model | T (V) | Voltage (V) | Current (A) | Ripple (mV) | Power Max(w) | Efficiency (V/ VI) |
|-----------------------|------------|-------------|-------------------------|-------------|--------------|---------------------|
| MSA-Z2500IS24.0-60X-Q | T1: 19-24V | 24 | 2.5A (Peak load>11A) | 240 | 60 | VI |

Adapter, Desktop

Input Voltage: 90~264Vac / 47~63Hz

Input Current: <1.8A

Start Inrush Current: No damage

Surge: CM: 4KV max; DM: 2KV max

Protection: OCP, SCP, OVP

Y Cap: With Y-cap

LED Display: Yes

Product Type: Desktop

Socket: 3PIN (C6, C14)

Dimension: 121.7*58*33.6mm

Working Temperature: 0~40°C

Safety: CCC, CE, CB, UL, FCC, BIS,
UKCA,

Application: ADSL Gateway,
Security Monitoring, Mobile Storage Device

65W

X30

Series:

X

 Security
(安防)

| Model | T (V) | Voltage (V) | Current (A) | Ripple (mV) | Power Max(w) | Efficiency (V/ VI) |
|--------------------|-----------|----------------|----------------|----------------|-----------------|-----------------------|
| MS-Z1360R480-065C0 | T1: 45-48 | 48 | 1.36 | 300 | 65 | VI |

Adapter, Wall-mount

Input Voltage: 90~264Vac / 47~63Hz

Input Current: <1.5A

Start Inrush Current: No damage

Surge: CM: 4KV max; DM: 2KV max

Protection: OCP, SCP, OVP

Y Cap: With Y-cap

LED Display: No

Product Type: Vertical

AC Plug: 3PIN (US & DE)

Dimension: 91*33.5*69.5mm

Working Temperature: 0~40°C

Safety: CCC, CE, CB, GS, UL, FCC,
UKCA, EAC, NOM, KC

Application: Monitor, Displayer
Audio and Video Player

65W

A30

Series:

A Display &
projector
(显示投影)



| Model | T (V) | Voltage (V) | Current (A) | Ripple (mV) | Power Max(w) | Efficiency (V/ VI) |
|--------------------|------------|----------------|----------------|----------------|-----------------|-----------------------|
| MS-V3420R190-065L0 | T1: 18-24V | 19 | 3.42 | 200 | 65 | VI |

Adapter, Desktop

Input Voltage: 90~264Vac /
47~63Hz

Input Current: <1.8A

Start Inrush Current: No damage

Surge: CM: 4KV max; DM: 4KV max

Protection: OCP, SCP, OVP

Y Cap: With Y-cap

LED Display: Yes

Product Type: Desk-top

Socket: 3PIN (C6, C14)

Dimension: 121*53.5*32mm

Working Temperature: 0~40°C

Safety: -

Application: Monitor, Displayer
Audio and Video Player

72W

A30

Series:

A Display &
projector
(显示投影)

**Under
development**

(开发中)



| Model | T (V) | Voltage (V) | Current (A) | Ripple (mV) | Power Max(w) | Efficiency (V/ VI) |
|--------------------|------------|----------------|----------------|----------------|-----------------|-----------------------|
| MS-Z3790R190-072B0 | T1: 18-20V | 19.0 | 3.79 | 240 | 72 | VI |

Adapter, Desktop

Input Voltage: 90~264Vac / 47~63Hz

Input Current: <1.8A

Start Inrush Current: No damage

Surge: CM: 4KV max; DM: 2KV max

Protection: OCP, SCP, OVP

Y Cap: With Y-cap

LED Display: Yes

Product Type: Desk-top

Socket: 3PIN (C6, C14)

Dimension: 142*60*32.5mm

Working Temperature: 0~40°C

Safety: CCC

Application: ADSL Gateway, Monitor, Displayer,
Audio and Video Player

90W
V30/ A30
Series:

V Netcom
(网通)

A Display &
projector
(显示投影)



| Model | T (V) | Voltage (V) | Current (A) | Ripple (mV) | Power Max(w) | Efficiency (V/ VI) |
|--------------------|------------|----------------|----------------|----------------|-----------------|-----------------------|
| MS-Z7000R120-090C0 | T1: 10-15V | 12.0 | 7.0 | 250 | 84 | VI |
| MS-Z4740R190-090C0 | T2: 18-20V | 19.0 | 4.74 | 250 | 90 | VI |

Adapter, Desktop

Input Voltage: 90~264Vac / 47~63Hz

Input Current: <1.8A

Start Inrush Current: No damage

Surge: CM: 6KV max; DM: 6KV max

Protection: OCP, SCP, OVP

Y Cap: With Y-cap

LED Display: Yes

Product Type: Desk-top

Socket: 3PIN (C6)

Dimension: 142*60*32.5mm

Working Temperature: 0~40°C

Safety: UL, FCC

Application: Monitor, Displayer
Audio and Video Player

90W

A30

Series:

A Display &
projector
(显示投影)



| Model | T (V) | Voltage (V) | Current (A) | Ripple (mV) | Power Max(w) | Efficiency (V/ VI) |
|---------------------|----------|----------------|----------------|----------------|-----------------|------------------------|
| A30-Z4000R190-090G0 | T1: 19V | 19.0 | 4.0 | 250 | 76 | VI |

Adapter, Wall-mount

Input Current: 200V~240V , Current<2.0A

Start Inrush Current: No damage

Surge: CM: 4KV max; DM: 2KV max

Protection: OCP, SCP, OVP

Y Cap: With Y-cap

LED Display: Yes

Product Type: Desk-top

Socket: 2PIN

Dimension: 70*70*31.5mm

Working Temperature: -10~40°C

Safety: CCC, CE,

Application: Monitor, Displayer
Audio and Video Player

110W

A30

Series:

A Display &
projector
(显示投影)



| Model | T (V) | Voltage (V) | Current (A) | Ripple P-P(mV) | Power Max(w) | Efficiency (V/ VI) |
|------------------------|----------|----------------|----------------|-------------------|-----------------|------------------------|
| A30-V5790R190-110G0-CN | T1: 19V | 19.0 | 5.79 | 20 | 110 | VI |

Adapter , Desktop

Input Current: 200V~240V , Current<2.0A

Start Inrush Current: No damage

Surge: CM: 4KV max; DM: 2KV max

Protection: OCP, SCP, OVP

Y Cap: With Y-cap

LED Display: Yes

Product Type: Desk-top

Socket: 2PIN

Dimension: 70*70*31.5mm

Working Temperature: -10~40°C

Safety: CCC, CE,

Application: Monitor, Displayer
Audio and Video Player

110W

A30

Series:

A Display &
projector
(显示投影)



| Model | T (V) | Voltage (V) | Current (A) | Ripple P-P(mV) | Power Max(w) | Efficiency (V/ VI) |
|------------------------|----------|----------------|----------------|-------------------|-----------------|------------------------|
| A30-V5790R190-110G0-CN | T1: 19V | 19.0 | 5.79 | 20 | 110 | VI |

Adapter, Desktop

Input Voltage: 90~264Vac / 47~63Hz

Input Current: <2.0A

Start Inrush Current: No damage

Surge: CM: 4KV max; DM: 2KV max

Protection: OCP, SCP, OVP

Y Cap: With Y-cap

LED Display: Yes

Product Type: Desk-top

Socket: 2PIN&3PIN (C6, C8)

Dimension: 156*63.5*31mm

Working Temperature: 0~40°C

Safety: CCC, CE, CB, UL, FCC, BSMI

Application: ADSL Gateway,
Security Monitoring

120W
V30/ A30
Series:

V Netcom
(网通)

A Display &
projector
(显示投影)



| Model | T (V) | Voltage (V) | Current (A) | Ripple (mV) | Power Max(w) | Efficiency (V/ VI) |
|----------------------|--------------|----------------|----------------|----------------|-----------------|-----------------------|
| MSS-ZA000WR120-120C0 | T1: 10-13.5V | 12.0 | 10.0 | 240 | 120 | VI |
| MSS-Z6320WR190-120C0 | T2: 18-20V | 19.0 | 6.32 | 300 | 120 | VI |
| MSS-Z5000WR240-120C0 | T3: 22-25V | 24.0 | 5.0 | 300 | 120 | VI |

Adapter, Desktop

Input Voltage: 90~264Vac / 47~63Hz

Input Current: <2.0A

Start Inrush Current: No damage

Surge: CM: 4KV max; DM: 2KV max

Protection: OCP, SCP, OVP

Y Cap: With Y-cap

LED Display: Yes

Product Type: Desk-top

Socket: 3PIN (C6)

Dimension: 156*63.5*31mm

Working Temperature: 0~40°C

Safety: CCC, CE, CB, UL, FCC, UKCA, KC, BSMI, BIS, UAE, EAC

Application: ADSL Gateway, Monitor, Displayer, Audio and Video Player, Security Monitoring

120W
V30/ A30
Series:

V Netcom
 (网通)

A Display & projector
 (显示投影)

X Security
 (安防)



| Model | T (V) | Voltage (V) | Current (A) | Ripple (mV) | Power Max(w) | Efficiency (V/VI) |
|--------------------|------------|-------------|-------------|-------------|--------------|-------------------|
| MS-ZA000R120-120D0 | T1: 10-15V | 12.0 | 10.0 | 240 | 120 | VI |
| MS-Z6320R190-120D0 | T2: 18-20V | 19.0 | 6.32 | 300 | 120 | VI |
| MS-Z5450R220-120D0 | T3: 22-25V | 22.0 | 5.45 | 300 | 120 | VI |
| MS-Z5000R240-120D0 | | 24.0 | 5.0 | 300 | 120 | VI |

Adapter, Desktop

Input Voltage: 90~264Vac / 47~63Hz

Input Current: <2.5A

Start Inrush Current: No damage

Surge: CM: 2KV max; DM: 2KV max

Protection: OCP, SCP, OVP

Y Cap: With Y-cap

LED Display: No

Product Type: Desk-top

Socket: 3PIN (C6, C14)

Dimension: 138.8*69.3*27mm

Working Temperature: 0~40°C

Safety: CCC, CE, CB, UL, FCC

Application: Monitor, Displayer
Audio and Video Player, ADSL Gateway,
Mobile Storage Device

150W
V30/ A30
Series:

V Netcom
(网通)

A Display &
projector
(显示投影)



| Model | T (V) | Voltage (V) | Current (A) | Ripple (mV) | Power Max(w) | Efficiency (V/ VI) |
|--------------------|------------|-------------|-------------|-------------|--------------|---------------------|
| MS-Z7000R200-150E0 | T1: 18-20V | 20.0 | 7.0 | 300 | 140 | VI |
| MS-Z6250R240-150E0 | T2: 22-25V | 24.0 | 6.25 | 300 | 150 | VI |

Adapter, Desktop

Input Voltage: 90~264Vac / 47~63Hz

Input Current: <2.5A

Start Inrush Current: No damage

Surge: CM: 2KV max; DM: 2KV max

Protection: OCP, SCP, OVP

Y Cap: With Y-cap

LED Display: No

Product Type: Desk-top

Socket: 3PIN (C6)

Dimension: 171*73*32.5mm

Working Temperature: 0~40°C

Safety: CCC

Application: Monitor, Displayer,
Audio and Video Player, Projector

180W

A30

Series:

A Display &
projector
(显示投影)



| Model | T (V) | Voltage (V) | Current (A) | Ripple (mV) | Power Max(w) | Efficiency (V/ VI) |
|-----------------------|------------|----------------|----------------|----------------|-----------------|-----------------------|
| A30-ZA000R180-180C0-E | T1: 18-20V | 18.0 | 10.0 | 300 | 180 | VI |

Adapter, Desktop

Input Voltage: 90~264Vac / 47~63Hz

Input Current: <3.0A

Start Inrush Current: No damage

Surge: CM: 4KV max; DM: 2KV max

Protection: OCP, SCP, OVP

Y Cap: With Y-cap

LED Display: No

Product Type: Desk-top

Socket: 3PIN (C6)

Dimension: 180*82.5*28.3mm

Working Temperature: 0~40°C

Safety: -

Application: Monitor, Displayer
Audio and Video Player

210W

A30

Series:

A Display &
projector
(显示投影)

Under
development

(开发中)



| Model | T (V) | Voltage (V) | Current (A) | Ripple (mV) | Power Max(w) | Efficiency (V/ VI) |
|--------------------|------------|----------------|----------------|----------------|-----------------|-----------------------|
| MS-ZA800R195-210A0 | T1: 18-20V | 19.5 | 10.8 | 380 | 210 | VI |

Adapter, Desktop

Input Voltage: 90~264Vac / 47~63Hz

Input Current: <4.0A

Start Inrush Current: No damage

Surge: CM: 2KV max; DM: 2KV max

Peak load: 34.2A for 10mS

Protection: OCP, SCP, OVP

Y Cap: With Y-cap

LED Display: No

Product Type: Desk-top

Socket: 3PIN (C6)

Dimension: 187*87*33mm

Working Temperature: 0~40°C

Safety: -

Application: Monitor, Displayer
Audio and Video Player

260W

**A30
Series:**

A Display &
projector
(显示投影)

**Under
development**

(开发中)



| Model | T (V) | Voltage (V) | Current (A) | Ripple (mV) | Power Max(w) | Efficiency (V/ VI) |
|---------------------|------------|----------------|---------------------------|----------------|-----------------|-----------------------|
| A30-ZA368R190-260A0 | T1: 18-20V | 19.0 | 13.68 (34.2A for 10mS) | 190 | 260 | VI |

Adapter, Desktop

Input Voltage: 90~264Vac / 47~63Hz

Input Current: <5.0A

Start Inrush Current: No damage

Surge: CM: 2KV max; DM: 2KV max

Peak load: 42A for 10mS

Protection: OCP, SCP, OVP

Y Cap: With Y-cap

LED Display: No

Product Type: Desk-top

Socket: 3PIN (C6)

Dimension: 200*95*35mm

Working Temperature: 0~40°C

Safety: -

Application: Monitor, Displayer,
Audio and Video Player

320W

**A30
Series:**

A Display &
projector
(显示投影)

**Under
development**

(开发中)



| Model | T (V) | Voltage (V) | Current (A) | Ripple (mV) | Power Max(w) | Efficiency (V/ VI) |
|---------------------|------------|----------------|-------------------------|----------------|-----------------|-----------------------|
| A30-ZA684R190-320A0 | T1: 18-20V | 19.0 | 16.84 (42A for 10mS) | 190 | 320 | VI |

MOSO Adapter, Desktop

350W
F30
Series:

F Shared power exchange
(充换电设备)

To be developed
(开发中)

| | |
|-------------------------------|--|
| 预充功能 | 满足 |
| 温度补偿 | / |
| 触发输出/低压起充 | 满足 |
| 通讯功能 | 雅迪一线通, 带CAN通讯 通过CAN 总线与电源设备交互通信, 包含工作状态、输入/输出电压、输入/输出电流温度、恒流/恒压、故障/正常等, 还可以与电池通讯, 可以知道电池电量, 充电时间设定, 涓流充电时间设定. |
| 熔断器 | 满足/用2个保险丝 |
| 连续插拔 | 满足/用软件控制, 2S内有转灯 |
| 其它 | PCB双面板UL94-V0, 温升要求<30k,用防火阻燃料UL94-V0, |
| 超时保护 | |
| 预充电超时 | 2.5-3H,电压<39V,故障 |
| 恒流充电超时 | 12±0.5H (负载CV测试) |
| 恒压充电超时 | 2.5-3H (负载CC测试) |
| 涓流充电超时 | 2.5-3H (负载CC测试) |
| 保护功能/Protection | |
| 过压保护/OVP | 125%Vo |
| 过流保护/OCP | 125%Io |
| 短路保护/short-circuit protection | 可持续、自恢复 |
| 过温保护 | 当环境温度达到到55度以上就降额输出 |
| 输出过冲/欠冲 | 满载开关机时, 输出过冲/欠冲均不大于5%。 |
| 防触电保护 | 满足, 用继电器 |
| 过充切断 | 满足, 用软件 |
| 防倒灌 | 满足, <1mA |
| 防反接 | DC端要有防反接功能 |
| AC残留电压 | <34V@1s后 |
| 风扇堵转 | / |



Open Frame

Input Current: 1.0A max

Start Inrush Current: 100A max

Surge: CM: 2KV max; DM: 1KV max

Peak load: 3A for 20mS

Protection: OCP, SCP, OVP

Y Cap: With Y-cap

Product Type: Open frame

Dimension: 160.2*16.5*15mm

Working Temperature: 0~40°C

Application: Electric lifting platform

24W

D30

Series:

D Motor
Drive
(电机驱动)



| Model | T (V) | Voltage (V) | Current (A) | Ripple (mV) | Power Max(w) | Efficiency (V/ VI) |
|--------------------|----------|----------------|--------------------|----------------|-----------------|-----------------------|
| MS-P2000J120-024A0 | T1: 12V | 12.0 | 2 (3A for 20mS) | 240 | 24 | VI |

Open Frame

Input Current: 0.4A max @ 25W
 0.8A max @ 25W
 1.0A max @ 35W

Start Inrush Current: 100A max
Surge: CM: 4KV max; DM: 2KV max

Protection: OCP, SCP, OVP

Y Cap: With Y-cap

Product Type: Open frame

Dimension: 90*37mm@15W
 97*50mm@25W
 115*60mm@35W

Working Temperature: -10~45°C

Application: Shared charging cabinet

15~35W

**S30
Series:**

S Sharable
chargers
(共享充电)



| Model | T (V) | Voltage (V) | Current (A) | Ripple (mV) | Power Max(w) | Efficiency (V/VI) |
|--------------------|--------|-------------|-------------|-------------|--------------|-------------------|
| MS-P3000B050-015B0 | T1: 5V | 5.0 | 3 | 100 | 15 | VI |
| MS-P5000A050-025D0 | T1: 5V | 5.0 | 5 | 100 | 25 | VI |
| MS-P7000A050-035B0 | T1: 5V | 5.0 | 7 | 100 | 35 | VI |

Open Frame

Input Current: 0.7A max @ 25W
1.0A max @ 35W

Start Inrush Current: 70A max
Surge: CM: 2KV max; DM: 1KV max
Protection: OCP, SCP, OVP

Y Cap: With Y-cap

Product Type: Open frame

Dimension: 120*80mm

Working Temperature: 0~50°C

Application: Displayer, Monitor

35W

A30

Series:

A Display &
projector
(显示投影)

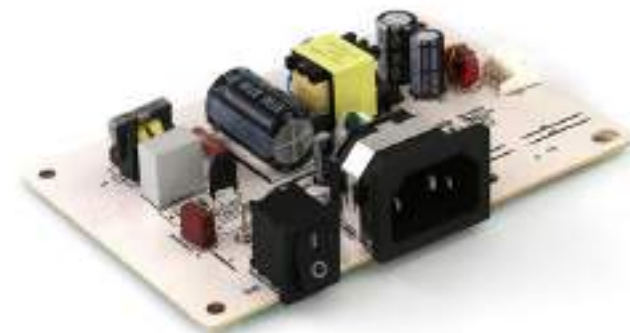

| Model | T (V) | Voltage (V) | Current (A) | Ripple (mV) | Power Max(w) | Efficiency (V/VI) |
|--------------------|---------|-------------|-------------|-------------|--------------|-------------------|
| MS-P1320J190-025A0 | T1: 19V | 19.0 | 1.32 | 380 | 25 | VI |
| MS-P1850J190-035A0 | T1: 19V | 19.0 | 1.85 | 380 | 35 | VI |

Open Frame

Input Voltage: 90~264Vac / 47~63Hz

Input Current: 2.5A max

Start Inrush Current: 100A max

Peak Current: 3.8A for 2min

Surge: CM: 4KV max; DM: 4KV max

Protection: OCP, SCP, OVP

Y Cap: With Y-cap

Product Type: Open frame

Dimension: 120*54*21mm

Working Temperature: 0~40°C

Application: Stereo

36W

H30

Series:

H

 Stereo
(音响)

| Model | T (V) | Voltage (V) | Current (A) | Ripple (mV) | Power Max(w) | Efficiency (V/ VI) |
|--------------------|----------|----------------|----------------|----------------|-----------------|-----------------------|
| MS-P1500J240-036N0 | T1: 24V | 24 | 1.5 | 200 | 36 | VI |

Open Frame

Input Current: 1.2A max

Start Inrush Current: 70A max

Surge: CM: 2KV max; DM: 1KV max

Protection: OCP, SCP, OVP

Y Cap: With Y-cap

Product Type: Open frame

Dimension: 120*80mm

Working Temperature: 0~50°C

Application: Displayer, Monitor

45W

A30

Series:

A Display &
projector
(显示投影)



| Model | T (V) | Voltage (V) | Current (A) | Ripple (mV) | Power Max(w) | Efficiency (V/ VI) |
|--------------------|----------|----------------|----------------|----------------|-----------------|-----------------------|
| MS-P2370J190-045A1 | T1: 19V | 19.0 | 2.37 | 380 | 45 | VI |

Open Frame

Input Current: 1.2A max @ 45W
 1.5A max @ 55W
 2.0A max @ 65W

Start Inrush Current: 100A max
Surge: CM: 4KV max; DM: 2KV max

Protection: OCP, SCP, OVP

Y Cap: With Y-cap

Product Type: Open frame

Dimension: 79*58mm@45W
 115*60mm@55W
 128*40mm@65W

Working Temperature: -10~45°C

Application: Shared charging cabinet

45~65W

**S30
Series:**

S Sharable
chargers
(共享充电)

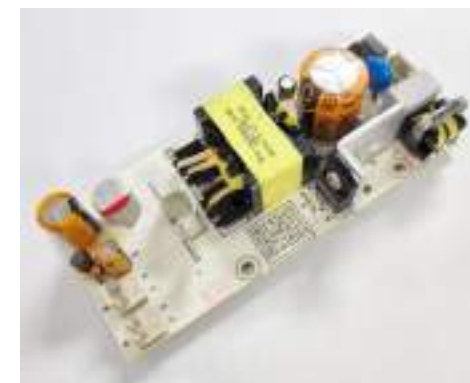

| Model | T (V) | Voltage (V) | Current (A) | Ripple (mV) | Power Max(w) | Efficiency (V/VI) |
|---------------------|--------|-------------|-------------|-------------|--------------|-------------------|
| MS-P9000B050-045B0 | T1: 5V | 5.0 | 9 | 100 | 45 | VI |
| MS-PA100A050-055A0 | T1: 5V | 5.0 | 11 | 100 | 55 | VI |
| S30-PA300J050-065H0 | T1: 5V | 5.0 | 13 | 100 | 65 | VI |

Open Frame

Input Current: 1.5A max@100-120Vac
3.0A max@200-240Vac

Start Inrush Current: No damage

Surge: CM: 2KV max; DM: 1KV max

Peak load : 380W

Protection: OCP, SCP, OVP

Y Cap: With Y-cap

Product Type: Open frame

Dimension: 145*86.8mm

Working Temperature: 0~40°C

Application: Electric lifting platform

65W

D30

Series:

D Motor
Drive
(电机驱动)



| Model | T (V) | Voltage (V) | Current (A) | Ripple (mV) | Power Max(w) | Efficiency (V/ VI) |
|--------------------|----------|----------------|----------------|----------------|-----------------|------------------------|
| MS-H1800R360-065S0 | T1: 36V | 36.0 | 1.8 | 250 | 64.8 | VI |

Open Frame

Input Current: 1.5A max

Start Inrush Current: 100A max

Surge: CM: 4KV max; DM: 2KV max

Protection: OCP, SCP, OVP

Y Cap: With Y-cap

Product Type: Open frame

Dimension: 150*60*26mm

Working Temperature: -10~45°C

Application: Shared charging cabinet

75W

S30

Series:

S Sharable
chargers
(共享充电)



| Model | T (V) | Voltage (V) | Current (A) | Ripple (mV) | Power Max(w) | Efficiency (V/ VI) |
|--------------------|----------|----------------|----------------|----------------|-----------------|-----------------------|
| MS-PA500A050-075A0 | T1: 5V | 5.0 | 15 | 100 | 75 | VI |

Open Frame

Input Current: 6.0A max

Start Inrush Current: No damage

Peak power: 300W

Surge: CM: 6KV max; DM: 6KV max

Protection: OCP, SCP, OVP

Y Cap: With Y-cap

Product Type: Open frame

Dimension: 151*70*55mm

Working Temperature: 0~40°C

Application: Stereo

108W

H30

Series:

H

 Stereo
(音响)

| Model | T (V) | Voltage (V) | Current (A) | Ripple (mV) | Power Max(w) | Efficiency (V/ VI) |
|--------------------|----------|--------------------------|----------------------|----------------|-----------------|-----------------------|
| MS-P3000R360-108A0 | - | CH1: 36.0V CH2: +5.0V | CH1: 3A CH2: 0.8A | 360 | 108 | VI |

Open Frame

Input Current: 10A max

Start Inrush Current: No damage

Peak power: 500W

Surge: CM: 2KV max; DM: 2KV max

Protection: OCP, SCP, OVP

Y Cap: With Y-cap

Product Type: Open frame

Dimension: 200*100mm

Working Temperature: 0~40°C

Application: Stereo

154W

H30

Series:

H

 Stereo
(音响)

| Model | T (V) | Voltage (V) | Current (A) | Ripple (mV) | Power Max(w) | Efficiency (V/ VI) |
|--------------------|----------|----------------|----------------|----------------|-----------------|-----------------------|
| MS-P3300J370-150A0 | T1: 37V | 37 | 3.33 | 360 | 154 | VI |

Open Frame

Input Current: <2.5A

Start Inrush Current: No damage

Surge: CM: 4KV max; DM: 2KV max

Peak load > 17A

Protection: OCP, SCP, OVP

Y Cap: With Y-cap

Product Type: Open frame

Dimension: 136.2*69.7*22.4mm

Working Temperature: 0~40°C

Application: Projector, Monitor
Displayer, Audio and Video Player

180W

A30

Series:

A Display &
projector
(显示投影)



| Model | T (V) | Voltage (V) | Current (A) | Ripple (mV) | Power Max(w) | Efficiency (V/ VI) |
|--------------------|----------|----------------|----------------|----------------|-----------------|-----------------------|
| MS-ZA000A180-180A0 | T1: 18V | 18.0 | 10.0 | 360 | 180 | VI |

Open Frame

Input Voltage: 198~264Vac / 47~50Hz

Input Current: 4.5A max

Start Inrush Current: 60A max

Surge: CM: 4KV max; DM: 1.5KV max

AC output peak power 620W

Protection: OCP, SCP, OVP

Y Cap: With Y-cap

Product Type: Open frame

Dimension: 280*67mm

Working Temperature: 0~40°C

Application: Business Printer

75W

M30

Series:

M Business
printer
(商用打印)

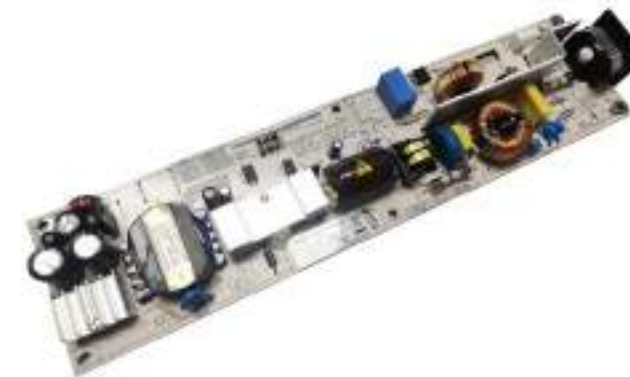

| Model | T (V) | Voltage (V) | Current (A) | Ripple (mV) | Power Max(w) | Efficiency (V/ VI) |
|----------------------|----------|--|------------------------------|----------------|-----------------|-----------------------|
| MSA-P3000BT250-075A0 | T1: 25V | CH1: 25.0 CH2:25.0/7V | CH1: 2.48 CH2: 0.52/1.733 | 300 | 75 | 85%@230Vac |

Open Frame

Input Current: 3.0A max

Start Inrush Current: 60A max

Surge: CM: 4KV max; DM: 2KV max

Peak load > 6A

Protection: OCP, SCP, OVP

Y Cap: With Y-cap

Product Type: Open frame

Dimension: 255*64mm

Working Temperature: -10~50°C

Application: Business Printer

108W

M30
Series:

M Business
printer
(商用打印)

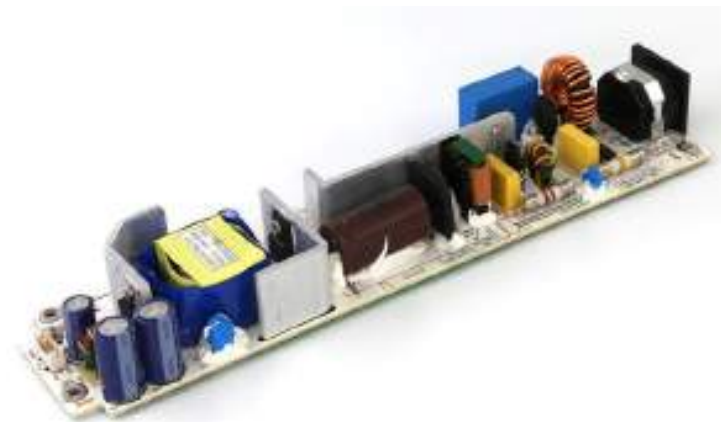

| Model | T (V) | Voltage (V) | Current (A) | Ripple (mV) | Power Max(w) | Efficiency (V/ VI) |
|-------------------|----------|----------------|----------------|----------------|-----------------|-----------------------|
| MS-P4500J240-110W | T1: 24V | 24.0 | 4.5 | 300 | 108 | VI |

Open Frame

110W

M

 Business
printer
(商用打印)

M30

Series:

Input Voltage: 187~264Vac / 47~50Hz
or 90~140Vac / 47~63Hz

Input Current: 3.5A max @187Vac
or 10A @ 90Vac

Start Inrush Current: No damage

Surge: CM: 4KV max; DM: 2KV max

AC Output Peak Power 695W

DC Output Peak Voltage: +5000V, -2100V
With zero crossing detection function

Protection: OCP, SCP, OVP

Y Cap: With Y-cap

Product Type: Open frame

Dimension: 290*155mm

Working Temperature: 0~32°C



| Model | T (V) | Voltage (V) | Current (A) | Ripple (mV) | Power Max(w) | Efficiency (V/ VI) |
|--------------------|----------|----------------|----------------|----------------|-----------------|-----------------------|
| MS-P3320J250-110E0 | T1: 25V | 25.0 | 3.32 | 300 | 180 | VI |

Open Frame

Input Voltage: 198~264Vac / 47~50Hz
or 90~140Vac / 47~63Hz

Input Current: 4A max @220Vac
or 6A @ 110Vac

Start Inrush Current: 80A max@220Vac

Efficiency: >82%

Surge: CM: 4KV max; DM: 2KV max

Protection: OCP, SCP, OVP

Y Cap: With Y-cap

Product Type: Open frame

Dimension: 192*100mm

Working Temperature: -10~45°C

Application: Business Printer

110W

M30

Series:

M Business printer
(商用打印)



| Model | T (V) | Voltage (V) | Current (A) | Ripple (mV) | Power Max(w) | Efficiency (V/ VI) |
|--|---------|---|----------------------------|-------------|--------------|---------------------|
| MSA-P4380AT250-112A0 MSA-P4380BT250-112A0 | T1: 25V | CH1: 25.0 CH2: 25.0/ 7.0 | CH1: 3.7 CH2: 0.68/ 0.4 | 300 | 110 | - |

Open Frame

Input Voltage: 187~264Vac / 47~50Hz
or 90~140Vac / 47~63Hz

Input Current: 1A max @187Vac
or 3A @ 90Vac

Start Inrush Current: 120A max

Surge: CM: 4KV max; DM: 4KV max

Peak load > 6.5A for 10mS

Protection: OCP, SCP, OVP

输出交流加热功能(OUTPUT AC HEATING FUNCTION)

Y Cap: With Y-cap

Product Type: Open frame

Dimension: 245*64*25mm

Working Temperature: -10~60°C

Application: Business Printer

72W

M30
Series:

M Business
printer
(商用打印)

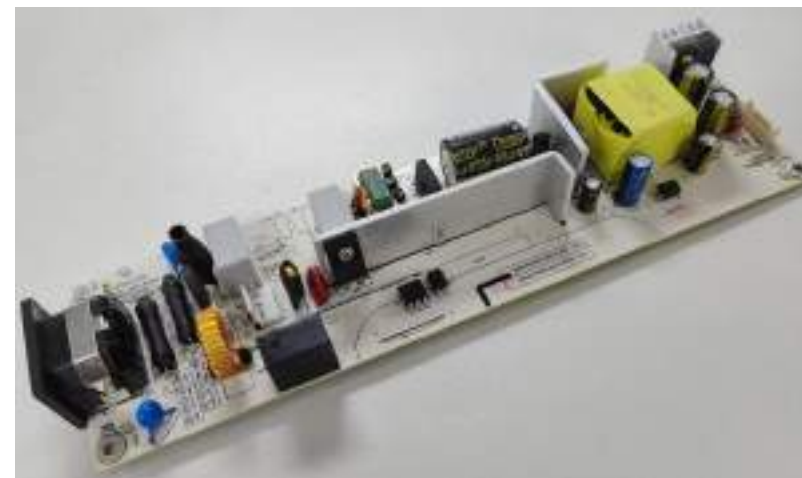

PANTUM 奔图



| Model | T (V) | Voltage (V) | Current (A) | Ripple (mV) | Power Max(w) | Efficiency (V/ VI) |
|-----------------------|----------|----------------|----------------|-------------------------|-----------------|-----------------------|
| M30-P3000J240-072D0/1 | T1: 24V | 24V / 8V | 3A / 0.3A | ≤240mV&24V ≤150mV&8V | 72 | VI |

Open Frame

Input Voltage: 187~264Vac / 47~50Hz
or 90~140Vac / 47~63Hz

Input Current: 3.5A max @187Vac
or 5A @ 90Vac

Start Inrush Current: 120A max

Surge: CM: 4KV max; DM: 4KV max

Peak load > 6.5A for 10mS

Protection: OCP, SCP, OVP

输出交流加热功能(OUTPUT AC HEATING FUNCTION)

Y Cap: With Y-cap

Product Type: Open frame

Dimension: 255*64*25mm

Working Temperature: -10~60°C

110W

M30
Series:

M Business
printer
(商用打印)

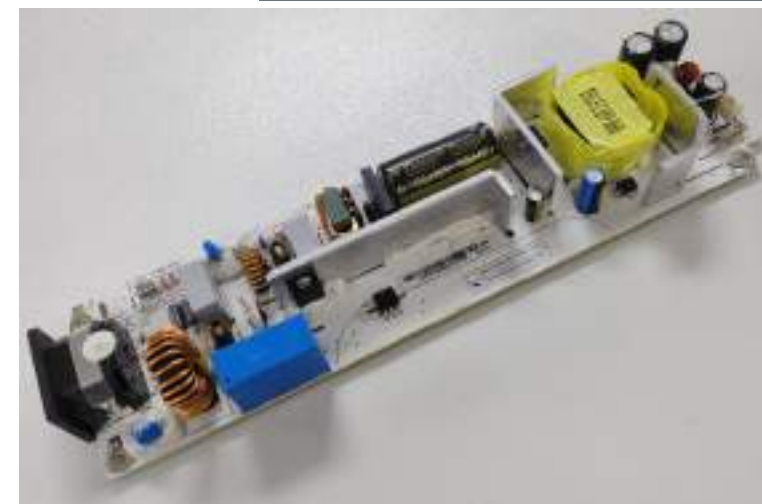

PANTUM 奔图



| Model | T (V) | Voltage (V) | Current (A) | Ripple (mV) | Power Max(w) | Efficiency (V/ VI) |
|----------------------|----------|----------------|----------------|-------------------------|-----------------|-----------------------|
| MS-P4500J240-110W0/1 | T1: 24V | 24V / 8V | 4.5A / 0.3A | ≤240mV&24V ≤150mV&8V | 110 | VI |

Open Frame

Input Voltage: 187~264Vac / 47~50Hz
or 90~140Vac / 47~63Hz

Input Current: 3.5A max @187Vac
or 5A @ 90Vac

Start Inrush Current: 120A max

Surge: CM: 4KV max; DM: 4KV max

Peak load > 6.5A for 10mS

Protection: OCP, SCP, OVP

输出交流加热功能(OUTPUT AC HEATING
FUNCTION)

Y Cap: With Y-cap

Product Type: Open frame

Dimension: 301.7*55*25mm

Working Temperature: -10~60°C

110W

**M30
Series:**

M Business
printer
(商用打印)

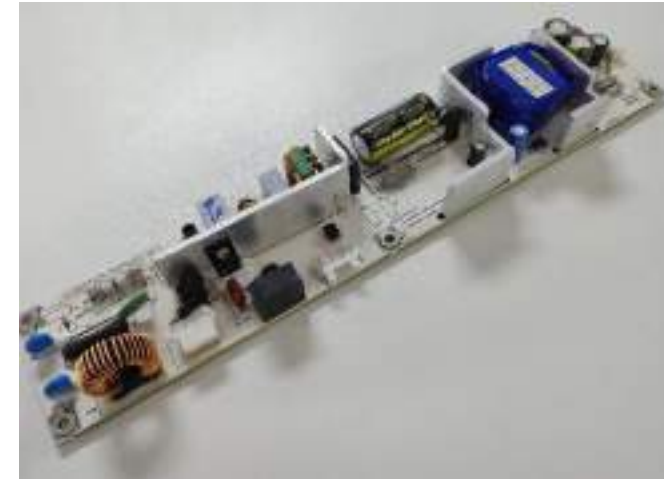

PANTUM 奔图



| Model | T (V) | Voltage (V) | Current (A) | Ripple (mV) | Power Max(w) | Efficiency (V/ VI) |
|----------------------|----------|----------------|----------------|----------------|-----------------|-----------------------|
| MS-P4500H240-110WH/L | T1: 24V | 24.0 | 4.5 | 240 | 110 | VI |

Input Voltage: 187~264Vac / 47~50Hz
or 90~140Vac / 47~63Hz

Input Current: 3A max @187Vac
or 5A @ 90Vac

Start Inrush Current: 80A max@220Vac

Efficiency: >85%@0-50% load
>86%@50-100% load

Surge: CM: 4KV max; DM: 2KV max

Peak load > 9A for 10mS

Protection: OCP, SCP, OVP

Y Cap: With Y-cap

Product Type: Open frame

Dimension: 165*130*40mm

Working Temperature: -10~45°C



| Model | T (V) | Voltage (V) | Current (A) | Ripple (mV) | Power Max(w) | Efficiency (V/ VI) |
|--------------------|----------|---|---------------------------------|----------------|-----------------|-----------------------|
| MS-P6000J240-150F0 | T1: 24V | CH1: 24.0 CH2: 24.0/ 7.0 | CH1: 2.48 CH2: 0.52/1.733 | 300 | 75 | - |

Open Frame

Input Voltage: 187~264Vac / 47~50Hz
or 90~140Vac / 47~63Hz

Input Current: 3.5A max @187Vac
or 5A @ 90Vac

Start Inrush Current: 120A max

Surge: CM: 4KV max; DM: 4KV max

Peak load > 12A for 10mS

Protection: OCP, SCP, OVP

Y Cap: With Y-cap

Product Type: Open frame

Dimension: 290*155mm

Working Temperature: -10~55°C

Application: Business Printer

180W

M30
Series:

M Business
printer
(商用打印)



| Model | T (V) | Voltage (V) | Current (A) | Ripple (mV) | Power Max(w) | Efficiency (V/ VI) |
|-----------------------|----------|----------------|----------------|----------------|-----------------|-----------------------|
| MS-P7500J240-180B0/B1 | T1: 24V | 24.0 | 7.5 | 240 | 180 | VI |

Input Voltage: 90~264V/47~63Hz
Input Current: 2.0A max @ 100~240Vac
 Withstand 300Vac input surge voltage for 5S
Surge: CM: 4KV max; DM: 2KV max

Efficiency: >88%
Standby Power: <0.5W
Protection: OLP, SCP, OVP

Cooling method: Self-cooling
Working temperature: -30~70°C/20%~95%RH
Dimension: 104*97*29.5 mm

Application: Industrial control systems,
 Electronic instruments, Industrial automation

75W
T30
Series:

T Industrial
 equipment
 (工业设备)



DVT已完成,
 试产中



| Model | T (V) | Voltage (V) | Current (A) | Ripple (mV) | Power Max(w) | Efficiency (V/VI) |
|--------------------|----------|----------------|----------------|----------------|-----------------|----------------------|
| MS-T6250J120-075C0 | T1: 12V | 12.0 | 6.25 | 120 | 75 | VI |
| MS-T3200J240-075C0 | T2: 24V | 24.0 | 3.2 | 200 | 76.8 | VI |

Input Voltage: 90~264V/47~63Hz
Input Current: 2.5A max @ 100~240Vac
 Withstand 300Vac input surge voltage for 5S
Surge: CM: 2KV max; DM: 1KV max

Efficiency: >88%
Standby Power: <0.5W
Protection: OLP, SCP, OVP

Cooling method: Self-cooling
Working temperature: -30~70°C/20%~95%RH
Dimension: 129*97*30mm

Application: Industrial control systems,
 Electronic instruments, Industrial automation

100W
T30
Series:

T Industrial
 equipment
 (工业设备)



24V已量产,
 12V DVT已完成,
 试产中



| Model | T (V) | Voltage (V) | Current (A) | Ripple (mV) | Power Max(w) | Efficiency (V/VI) |
|--------------------|----------|----------------|----------------|----------------|-----------------|----------------------|
| MS-P8330J120-100A0 | T1: 12V | 12.0 | 8.33 | 120 | 100 | VI |
| MS-P4170A240-100A0 | T2: 24V | 24.0 | 4.17 | 200 | 100 | VI |

Industrial Power

Input Voltage: 100~120Vac or 200 ~ 240Vac
/47~63Hz (Adjust by switch)

Input Current: 1.7A max @ 230Vac,
3.0A max @ 115Vac

Withstand 300Vac input surge voltage for 5S

Surge: CM/DM: 2KV max

Efficiency: >88%

Standby Power: <0.6W

Protection: OLP, SCP, OVP

Cooling method: Self-cooling

Working temperature: -30~70°C/20%~95%RH

Dimension: 159*97*30 mm

Application: Industrial control systems,
Electronic instruments, Industrial automation,
3D Printer

150W
T30/E30
Series:

T Industrial equipment
(工业设备)

E Industrial equipment
(工业设备)



12V已量产
24V&48V DVT
已完成, 试产中



| Model | T (V) | Voltage (V) | Current (A) | Ripple (mV) | Power Max(w) | Efficiency (V/ VI) |
|--------------------|---------|-------------|-------------|-------------|--------------|---------------------|
| MS-TA250J120-150A0 | T1: 12V | 12.0 | 12.5 | 120 | 150 | VI |
| MS-T6500J240-150A0 | T2: 24V | 24.0 | 6.5 | 200 | 156 | VI |
| MS-T3130J480-150A0 | T3: 48V | 48.0 | 3.125 | 300 | 150 | VI |

MOSO Industrial Power (no-PFC)

Input Voltage: 100~120Vac or 200~240Vac
/47~63Hz (Adjust by switch)

Input Current: 3.5A max @ 230Vac,
6.8A max @ 100Vac

Withstand 300Vac input surge voltage for 5S

Efficiency: >88%

Standby Power: <2.0W

Protection: OLP, SCP, OVP, OTP

Cooling method: Fan-cooling

Working temperature: -30~70°C/20%~95%RH

Dimension: 215*115*29 mm

Application: Industrial control systems,
Electronic instruments, Industrial automation,
3D Printer

350W

T30/E30

Series:

T Industrial equipment
(工业设备)

E Industrial equipment
(工业设备)



24V已量产
48V DVT测试中



| Model | T (V) | Voltage (V) | Current (A) | Ripple (mV) | Power Max(w) | Efficiency (V/VI) |
|----------------------|---------|-------------|-------------|-------------|--------------|-------------------|
| MSA-TA460DR240-350A0 | T1: 24V | 24.0 | 14.6 | 200 | 350 | VI |
| MS-T7290A480-350A0 | T2: 48V | 48.0 | 7.5 | 300 | 360 | VI |

Input Voltage: 90 ~ 264Vac /47~63Hz
Input Current: 6.0A max
 Withstand 300Vac input surge voltage for 5S

Efficiency: >88%
Standby Power: <2.0W
Protection: OLP, SCP, OVP, OTP

With PFC Function > 0.95
Cooling method: Fan-cooling
Working temperature: -30~70°C/20%~95%RH
Dimension: 215*115*29 mm

Application: Industrial control systems,
 Electronic instruments, Industrial automation,
 3D Printer

350W

E30
Series:E 3D Printer
(3D打印机)

| Model | T (V) | Voltage (V) | Current (A) | Ripple (mV) | Power Max(w) | Efficiency (V/ VI) |
|--------------------|----------|----------------|----------------|----------------|-----------------|-----------------------|
| MS-TA460J240-350B0 | T1: 24V | 24.0 | 14.6 | 200 | 350 | VI |

Input Voltage: 100 ~ 120Vac or 200~240Vac
/47~63Hz (Adjust by switch) or 254~370Vdc

Input Current: 6.0A max @ 230Vac,
10.0A max @ 115Vac

Withstand 300Vac input surge voltage for 5S

Efficiency: >88%

Protection: OLP, SCP, OVP, OTP

Cooling method: Fan-cooling

Working temperature: -30~70°C/20%~95%RH

Dimension: 225*124*50mm

Application: Industrial control systems,
Electronic instruments, Industrial automation,
3D Printer

450W

E30

Series:

T Industrial
equipment
(工业设备)

E 3D Printer
(3D打印机)

To be
developed

(待立项开发)



| Model | T (V) | Voltage (V) | Current (A) | Ripple (mV) | Power Max(w) | Efficiency (V/ VI) |
|--------------------|----------|----------------|----------------|----------------|-----------------|-----------------------|
| MS-PA875A240-450A0 | T1: 24V | 24.0 | 18.75 | 240 | 450 | VI |

Input Voltage: 90 ~ 264Vac /47~63Hz

Input Current: 2.52A max @ 230Vac,
5.8A max @ 100Vac

Withstand 300Vac input surge voltage for 5S

Efficiency: >89%

Standby Power: <10.0W

Protection: OLP, SCP, OVP, OTP

With PFC function > 0.98

Cooling method: Fan-cooling

Working temperature: -30~70°C/20%~95%RH

Dimension: 230*127*40 mm

Application: Industrial control systems,
Electronic instruments, Industrial automation
3D printers

500W

T30/E30

Series:

T Industrial
equipment
(工业设备)

E 3D Printer
(3D打印机)



| Model | T (V) | Voltage (V) | Current (A) | Ripple (mV) | Power Max(w) | Efficiency (V/ VI) |
|--------------------|----------|----------------|----------------|----------------|-----------------|-----------------------|
| MS-TB100J240-500C0 | T1: 24V | 24.0 | 21 | 200 | 504 | VI |

500W

F30

Series:

F Shared power
exchange
(换电设备)**Input Voltage:** 176 ~ 264Vac /47~63Hz**Input Current:** 5.0A max @ 230Vac

Withstand 300Vac input surge voltage for 5S

Surge voltage: 4KV/2KV**Efficiency:** > 92%@ 220Vac at 80% load**Standby Power:** <1.5W@220Vac**Protection:** OLP, SCP, OVP, OTP**With PFC function > 0.98****Cooling method:** Fan-cooling**Working temperature:** -25~65°C/20%~95%RH**Dimension:** 220*118*50.8 mm**Other function:** MODBUS-RTU protocol**Application:** Charging station

| Model | Communication protocol | Voltage (V) | Current (A) | Ripple (mV) | Power Max(w) | Efficiency (V/ VI) |
|--------------------|------------------------|-------------|-------------|-------------|--------------|--------------------|
| MS-T8000R540-430A1 | CAN | 54.0 | 0-9A | 500 | 500 | VI |
| MS-T8000R540-430A2 | 485 | 54.0 | 0-9A | 500 | 500 | VI |

Input Voltage: 90 ~ 264Vac /47~63Hz

Input Current: 5.0A max @ 230Vac,
8.5A max @ 115Vac

Withstand 300Vac input surge voltage for 5S

Surge: CM: 6KV max; DM: 3KV max

Efficiency: >89%

Standby Power: <10.0W

Protection: OLP, SCP, OVP, OTP

With PFC function > 0.94

Cooling method: Fan-cooling

Working temperature: -30~70°C/20%~95%RH

Dimension: 220*120*50 mm

Application: Industrial control systems,
Electronic instruments, Industrial automation
3D printers

650W

T30/E30
Series:

T Industrial equipment
(工业设备)

E 3D Printer
(3D打印机)

M Business printer
(商用打印)

Research
Developing

(开发中)

EVT阶段



| Model | T (V) | Voltage (V) | Current (A) | Ripple (mV) | Power Max(w) | Efficiency (V/ VI) |
|--------------------|----------|----------------|----------------|----------------|-----------------|-----------------------|
| MS-PB700A240-650A0 | T1: 24V | 24.0 | 27 | 200 | 650 | VI |

Input Voltage: 90 ~ 264Vac /47~63Hz

Input Current: TBD

Surge: CM: 4KV max; DM: 2KV max

Efficiency: >92%@ 220Vac at 73Vdc with 80% load

Standby Power: <3W@220Vac

Protection: OLP, SCP, OVP, OTP, Input OVP

Communication protocol: CAN or 485

With PFC function > 0.98

Cooling method: Fan-cooling

Working temperature: -25~65°C/0%~95%RH

Dimension: 220*120*50 mm

Application: Charging station

750W
F30
Series:

F Shared power
exchange
(换电设备)

**Research
Developing**

(开发中)

EVT阶段



| Model | Voltage (V) | Current (A) | Ripple (mV) | Power Max(w) | Efficiency (V/ VI) |
|---------------------|-------------|-------------|-------------|--------------|---------------------|
| F30-TA000J750-750A0 | 40-75 | 0-10A | 600 | 750 | VI |

800W
T30/E30
Series:

T Industrial equipment
 (工业设备)

E 3D Printer
 (3D打印机)

Research Developing
 (开发中)

Input Voltage: 90 ~ 264Vac /47~63Hz
Input Current: 5.0A max @ 220Vac,
 8.0A max @ 110Vac
 Withstand 300Vac input surge voltage for 5S

Efficiency: >92% @220Vac
Standby Power: <5.0W
Protection: OLP, SCP, OVP, OTP

With PFC function > 0.95
Cooling method: Fan-cooling
Working temperature: -30~70°C/20%~95%RH
Dimension: 218*116.5*40.5mm



24V已完成DVT
 36V&48V 待开发

Application: Industrial control systems,
 Electronic instruments, Industrial automation
 3D printers



| Model | T (V) | Voltage (V) | Current (A) | Ripple (mV) | Power Max(w) | Efficiency (V/ VI) |
|--------------------|---------|-------------|--------------------|-------------|--------------|--------------------|
| MS-TC125J240-800A0 | T1: 24V | 24.0 | 31.25 | 240 | 750W | VI |
| MS-TB220J360-800A0 | T2: 36V | 36.0 | 22.2A @176-264Vac | 360 | 800W | VI |
| | | | 17.78A @ 90-176Vac | | 640W | |
| MS-TA570J480-800A0 | T3: 48V | 48.0 | 15.7 | 480 | 750W | VI |

Input Voltage: 85 ~ 300Vac /47~63Hz

Input Current: 5A max

Surge: CM: 2KV max; DM: 2KV max

Efficiency: >93%220Vac, 72Vdc with full load

Standby Power: <3W

Protection: OLP, SCP, OVP, OTP, Input OVP

Communication protocol: CAN or 485

With PFC function > 0.98

Cooling method: Fan-cooling

Working temperature: -20~50°C/20%~95%RH

Dimension: 199*98*50mm

Application: Charging station

1200W

F40

Series:

F Shared power
exchange
(充换电设备)

**To be
developed**

(待立项开发)

外观图待定



| Model | Voltage (V) | Current (A) | Ripple (mV) | Power Max(w) | Efficiency (V/ VI) |
|---------------------|----------------|----------------|----------------|-----------------|-----------------------|
| F40-TA500J840-1K2A0 | 40-84 | 15 | 900 | 1260 | VI |

Input Voltage: 85 ~ 300Vac /47~63Hz
85~180Vac /47~63Hz@half load

Input Current: TBD

Surge: CM: 2KV max; DM: 2KV max

Efficiency: >93%@220Vac, 72Vdc with full load

Standby Power: <3W

Protection: OLP, SCP, OVP, OTP, Input OVP

Communication protocol: CAN or 485

With PFC function > 0.98

Cooling method: Fan-cooling

Working temperature: -20~50°C/20%~95%RH

Dimension: 241*124*65mm

Application: Charging station

1800W

F40

Series:

F Shared power
exchange
(充换电设备)

To be
developed

(待立项开发)

外观图待定



| Model | Voltage (V) | Current (A) | Ripple (mV) | Power Max(w) | Efficiency (V/ VI) |
|---------------------|-------------|-------------|-------------|--------------|--------------------|
| F40-TB200J880-1K8A0 | 40-88 | 20 | 900 | 1760 | VI |

Input Voltage: 86 ~ 275Vac /47~63Hz
86~175Vac /47~63Hz@half load

Input Current: TBD

Surge: CM: 5KV max; DM: 5KV max

Efficiency: >93%@40%~90% load

Standby Power: <3W

Protection: OLP, SCP, OVP, OTP, Input OVP

Communication protocol: CAN or 485

With PFC function > 0.98

Cooling method: Fan-cooling

Working temperature: -20~50°C/20%~95%RH

Dimension: TBD

Application: Charging station

外观图待定



| Model | Voltage (V) | Current (A) | Ripple (mV) | Power Max(w) | Efficiency (V/ VI) |
|---------------------|--------------------------|-------------------------|-------------|---|--------------------|
| F40-TB000J750-1K8B0 | CH1: 39-75 CH2: 39-75 | CH1/CH2: 20A max | 1500 | CH1: 1200W, CH2: 1200W CH1+CH2: 1800W | VI |
| F40-TA500J750-1K8C0 | CH1: 39-75 CH2: 39-75 | CH1/CH2/CH3: 15A max | 1500 | CH1: 750W, CH2: 750W CH3: 750W CH1+CH2+CH3: 1800W | VI |

Input Voltage: 85 ~ 300Vac /47~63Hz
85~180Vac /47~63Hz@half load

Input Current: TBD

Surge: CM: 2KV max; DM: 2KV max

Efficiency: >93%@220Vac, 72Vdc with full load

Standby Power: <3W

Protection: OLP, SCP, OVP, OTP, Input OVP

Communication protocol: CAN or 485

With PFC function > 0.98

Cooling method: Fan-cooling

Working temperature: -20~50°C/20%~95%RH

Dimension:

Application: 植物工厂系统



参考图



| Model | Voltage (V) | Current (A) | Ripple P-P(mV) | Power Max(w) | Efficiency (V/ VI) |
|-------|-------------|-------------|----------------|--------------|--------------------|
| T40 | 36 | 50 | 900 | 1800 | VI |

Input Voltage: 180 ~ 264Vac /47~63Hz

Surge: CM: 4KV max; DM: 2KV max

Efficiency: >88%@220Vac

Standby Power: <2.0W

Protection: OLP, SCP, OVP, OTP

Cooling method: Self-cooling

Working temperature: -20~50°C/10%~90%RH

Dimension: 127.2*77.3*37mm

Application: Network switch

150W

N30

Series:

N Network
Switch
(网络交换机)

CE FC CB UL

| Model | T (V) | Voltage (V) | Current (A) | Ripple (mV) | Power Max(w) | Efficiency (V/ VI) |
|---------------------|----------|----------------|----------------|----------------|-----------------|-----------------------|
| N30-P2800J535-150A0 | - | 53.5 | 2.8 | 300 | 150 | VI |

Input Voltage: 180 ~ 264Vac /47~63Hz

Surge: CM: 4KV max; DM: 2KV max

Efficiency: >88%@220Vac

Standby Power: <2.0W

Protection: OLP, SCP, OVP, OTP

Cooling method: Self-cooling

Working temperature: -20~50°C/10%~90%RH

Dimension: 157*77.5*37mm

Application: Ethernet



| Model | T (V) | Voltage (V) | Current (A) | Ripple (mV) | Power Max(w) | Efficiency (V/ VI) |
|---------------------|----------|----------------|----------------|----------------|-----------------|------------------------|
| N30-P4700J535-250A0 | - | 53.5 | 4.7 | 300 | 250 | VI |

PD Charger(Car charger)

Input Voltage: 10.8~26.4Vdc

Input Current: 0.6A max @ 12~24Vdc

Surge: CM: 2KV max; DM: 1KV max

Protection: OCP, SCP, OVP, OTP

Y Cap: With Y-cap

Product Type: Car charger

Charging protocol: QC4.0+/PD3.0/PPS, etc.

Dimension: $\Phi 23.6 \times 49\text{mm}$

Working Temperature: -10~25°C

Safety: CE

Application: Smart phones, Tablets and other 3C electronic products.

20W

P30

Series:

P 3C
electronic
(3C电子产品)



| Model | Output ports | Voltage (V) | Current (A) | Ripple (mV) | Power Max(w) | Efficiency (V/ VI) |
|--------------------|--------------|---|-------------|-------------|--------------|--------------------|
| MS-H1670U120-020C0 | 1C | USB-C: 3.3-11V/2A, 5V/3A, 9V/2.22A, 12V/1.67A | | 100 | 20W | VI |

PD Charger, Wall-mount

Input Voltage: 90 ~ 264Vac /47~63Hz

Input Current: 0.6A max

Surge: CM: 2KV max; DM: 1KV max

Protection: OCP, SCP, OVP, OTP

Y Cap: With Y-cap

Product Type: Vertical

Charging protocol: QC4.0+/PD3.0/PPS, etc.

Dimension: 30*30*31mm

Working Temperature: -10~25°C

Safety: CCC, FCC, UL/cUL, CE, UL(Amazon)

Application: Smart phones, Tablets and other 3C electronic products.

20W

P30

Series:

GaN

P 3C
electronic
(3C电子产品)



| Model | Output ports | Voltage (V) | Current (A) | Ripple (mV) | Power Max(w) | Efficiency (V/ VI) |
|--------------------|--------------|---|-------------|-------------|--------------|---------------------|
| MS-H1670U120-020C0 | 1C | USB-C: 3.3-11V/1.8A, 5V/3A, 9V/2.22A, 12V/1.67A | | 100 | 20W | VI |
| MS-H1670U120-020F0 | 1C | USB-C: 3.3-11V/3A, 5V/3A, 9V/2.22A, 12V/1.67A | | 100 | 20W | VI |

PD Charger, Wall-mount

Input Voltage: 90 ~ 264Vac /47~63Hz

Input Current: 0.6A max

Surge: CM: 2KV max; DM: 1KV max

Protection: OCP, SCP, OVP, OTP

Y Cap: With Y-cap

Product Type: Horizontal

Charging protocol: QC4.0+/PD3.0/PPS, etc.

Dimension: 73*36*14mm

Working Temperature: -10~25°C

Safety: -

Application: Smart phones, Tablets and other 3C electronic products.

20W

P30

Series:

GaN

P 3C
electronic
(3C电子产品)

Research Deve
loping
(开发中)



| Model | Output ports | Voltage (V) | Current (A) | Ripple (mV) | Power Max(w) | Efficiency (V/ VI) |
|--------------------|--------------|---|-------------|-------------|--------------|---------------------|
| MS-V3000U050-020D0 | 1C | USB-C: 3.3-11V/2A, 5V/3A, 9V/2.22A, 12V/1.67A | | 100 | 20W | VI |

PD Charger, Wall-mount

Input Voltage: 90 ~ 264Vac /47~63Hz

Input Current: 1.0A max

Surge: CM: 2KV max; DM: 1KV max

Protection: OCP, SCP, OVP, OTP

Y Cap: With Y-cap

Product Type: Vertical

Charging protocol: QC4.0+/PD3.0/PPS, etc.

Dimension: 030F0: 38*38*35mm

030L0: 31.8*31.8*37.5mm(Folding Pin)

Working Temperature: -10~25°C

Safety (030F0) : CCC, FCC, UL/cUL, CE, UKCA, PSE

Safety (030L0) : FCC, UL(Amazon)

30W
P30
Series:
GaN

P 3C
 electronic
 (3C电子产品)



Application: Smart phones, Tablets and other

| Model | Output ports | Voltage (V) | Current (A) | Ripple (mV) | Power Max(w) | Efficiency (V/ VI) |
|--------------------|--------------|---|-------------|-------------|--------------|---------------------|
| MS-V1500U200-030F0 | 1C | USB-C: 3.3-11V/3A, 5V/3A, 9V/3A, 12V/2.5A, 15V/2A, 20V/1.5A | | 200 | 30W | VI |
| MS-V1500U200-030L0 | 1C | USB-C: 3.3-11V/3A, 5V/3A, 9V/3A, 12V/2.5A, 15V/2A, 20V/1.5A | | 200 | 30W | VI |

PD Charger, Wall-mount

Input Voltage: 90 ~ 264Vac /47~63Hz

Input Current: 1.0A max

Surge: CM: 2KV max; DM: 1KV max

Protection: OCP, SCP, OVP, OTP

Y Cap: With Y-cap

Product Type: Vertical

Charging protocol: QC4.0+/PD3.0/PPS, etc.

Dimension: 37.3*37.3*35.3mm

Working Temperature: -10~25°C

Safety: FCC, CE, UKCA, UL(Amazon)

Application: Smart phones, Tablets and other 3C electronic products.

GaN

30W

P30T

Series:

P 3C electronic
(3C电子产品)



| Model | Output ports | Voltage (V) | Current (A) | Ripple (mV) | Power Max(w) | Efficiency (V/ VI) |
|--------------------|--------------|--|-------------|-------------|--------------|--------------------|
| MS-V1500U200-030I0 | 1C+1A | USB-C: 3.3-11V/3A, 5V/3A, 9V/3A, 12V/2.75A, 15V/2.2A, 20V/1.65A USB-A: 5V/3A, 9V/3A, 12V/2.5A USB C+USB A: 20W+10W | | 200 | 30W | VI |

PD Charger, Wall-mount

Input Voltage: 90 ~ 264Vac /47~63Hz

Input Current: 1.5A max

Surge: CM: 2KV max; DM: 1KV max

Protection: OCP, SCP, OVP, OTP

Y Cap: With Y-cap

Product Type: Vertical

Charging protocol: QC4.0+/PD3.0/PPS, etc.

Dimension: 55*32.5*54mm

Working Temperature: -10~25°C

Safety: CE

Application: Smart phones, Tablets, Laptops and other 3C electronic products.

GaN

40W

P30

Series:

P 3C electronic
(3C电子产品)



| Model | Output ports | Voltage (V) | Current (A) | Ripple (mV) | Power Max(w) | Efficiency (V/ VI) |
|--------------------|--------------|--|-------------|-------------|--------------|--------------------|
| MS-V3000U050-040P0 | 2C | USB-C1: 3.3-11V/1.8A, 5V/3A, 9V/2.22A, 12V/1.67A USB-C2: 3.3-11V/1.8A, 5V/3A, 9V/2.22A, 12V/1.67A USB C1+C2: 20W+20W | | 200 | 40W | VI |

PD Charger, Wall-mount

Input Voltage: 90 ~ 264Vac /47~63Hz

Input Current: 2.0A max

Surge: CM: 2KV max; DM: 1KV max

Protection: OCP, SCP, OVP, OTP

Y Cap: With Y-cap

Product Type: Vertical

Charging protocol: QC4.0+/PD3.0/PPS, etc.

Dimension: 55*32.5*54mm

Working Temperature: -10~25°C

Safety: CCC, CE, FCC, UL(Amazon), UKCA, UL/cUL

Application: Smart phones, Tablets, Laptops and other 3C electronic products.

GaN

65W

P30

Series:

P 3C electronic
(3C电子产品)



| Model | Output ports | Voltage (V) | Current (A) | Ripple (mV) | Power Max(w) | Efficiency (V/ VI) |
|--------------------|--------------|---|-------------|-------------|--------------|---------------------|
| MS-V3250U200-065P0 | 2C | USB-C1: 3.3-11V/5A, 5V/3A/9V 3A, 15V/3A, 20V/3.25A USB-C2: 3.3-11V/5A, 5V/3A, 9V/3A, 15V/3A, 20V/3.25A USB C1+C2: 45W+20W | | 200 | 65W | VI |

PD Charger, Wall-mount

Input Voltage: 90 ~ 264Vac /47~63Hz

Input Current: 2.0A max

Surge: CM: 2KV max; DM: 1KV max

Protection: OCP, SCP, OVP, OTP

Y Cap: With Y-cap

Product Type: Vertical

Charging protocol: QC5.0/PD3.0/PPS, etc.

Dimension: 67*67*30.5mm

Working Temperature: -10~25°C

Safety: CE

Application: Smart phones, Tablets, Laptops and other 3C electronic products.

100W
P30T
Series:
GaN

P 3C
 electronic
 (3C电子产品)



| Model | Output ports | Voltage (V) | Current (A) | Ripple (mV) | Power Max(w) | Efficiency (V/ VI) |
|--------------------|--------------|--|-------------|-------------|--------------|---------------------|
| MS-V5000U200-100A0 | 1C+1A | USB-C: 3.3V~21V/3.25A, 5V/3A, 9V/3A, 10V/2.2A, 12V/3A, 15V/3A, 20V/5A USB-A: 5V/3A, 9V/3A, 12V/2.5A, 20V/1.5A USB C+USB A: 65W+12W | | 200 | 100W | VI |

PD Charger, Wall-mount

Input Voltage: 90 ~ 264Vac /47~63Hz

Input Current: 3.0A max

Surge: CM: 2KV max; DM: 1KV max

Protection: OCP, SCP, OVP, OTP

Y Cap: With Y-cap

Product Type: Vertical

Charging protocol: QC5.0/PD3.0/PPS, etc.

Dimension: 117*60*23mm

Working Temperature: -10~25°C

Safety:

Application: Smart phones, Tablets, Laptops and other 3C electronic products.

240W
P40 Series:
GaN

P 3C electronic
 (3C电子产品)

Under development
 (开发中)



| Model | Output ports | Voltage (V) | Current (A) | Ripple (mV) | Power Max(w) | Efficiency (V/ VI) |
|-------|--------------|-------------|-------------|-------------|--------------|---------------------|
| | | | | 200 | 240W | VI |



LED BU Smart Driver Product Application



Road Lighting



Plant Lighting



High Power Lighting



Industrial Lighting



Landscape Lighting



Large Space Lighting



LED BU Product lines corresponding to Application



THANKS

MOSO | SPS BU | JAMA Technology

Technology Innovation & Product Supremacy

Please consult the sales department for more product information.

Maker :Product Management Dept. | Bobby BIE

MOSO Power Technology Co., Ltd.

www.mosopower.com

MOSO[®]
STOCK CODE:002660